

THE GERM FREE AUTOMATED ENVIRONMENT

CATALOGUE

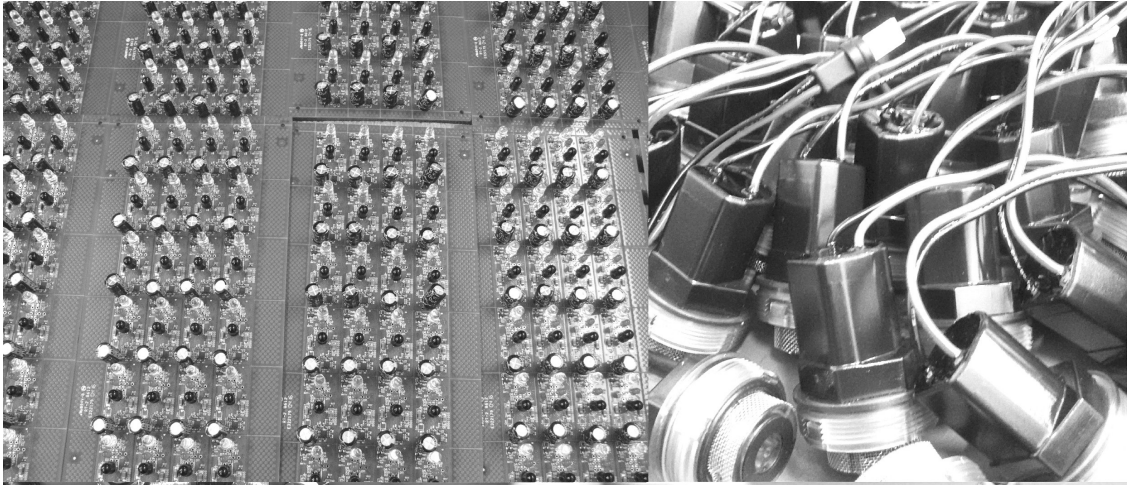

stern
STERN ENGINEERING LTD.





STERN ALWAYS COMMITTED TO GREEN BUILDING AND WATER EFFICIENCY PRODUCTS

A pioneer in the design of water conservation products with cutting-edge infrared technology, Stern has been producing electronic sanitary products since 1989.

Due to years of chronic water shortage, Stern has been dedicated, since the very first years of its existence, to creating products and technologies that decrease water demand for public and urban use. Stern owns several patents in the field and was one of the first electronic faucets producers. As a groundbreaker, Stern has introduced the public sector to the use of water saving technologies such as: dual flush in electronic flush valves, Piezo activated products with programmable settings and the use of remote control for more effective reduced water consumption.

Stern is the primary manufacturer exclusively producing both the machined product bodies as well as the critical electronic components: solenoid valves, infrared sensors and piezo switches.



Stern's innovative minds are leading the way

With 28 years of successful innovations, Stern has the experience and skill to anticipate consumers' needs. Stern's wide range of touchless products is the result of developing the sanitary solutions to meet those needs:



Lavatory touch free or touch operated faucets, minimalist, angled or robust designs that suit any decorative style.



Wall mounted touch free faucets or touch operated faucets, usually the selected option for the medical sector, wall mounted faucets are also ideal for refurbishment projects.



Touch free soap dispensers to be used with non-proprietary liquid or foam soap.



Behind the mirror lines operated by IR sensor. Options include faucets, soap dispensers and hand dryers for integration behind the mirror and full cabinet.



Touch free exposed or concealed flush valves for W.C. with or without iron frame.



Touch free flush valves for urinals, exposed or concealed versions.



Iron mounting frame set. Innovative system for touch free soap dispenser and touch free faucet, providing a complete solution.



Foot washers. Electronically operated self-closing foot washers for heavy duty areas.



Eco-friendly shower panels, shower controls and shower heads. Vandal resistant products operated by sensor or touch.





STERN'S GREEN BUILDING AND WATER EFFICIENCY PRODUCTS

Stern Engineering places a high priority on products that address today's water conservation concerns. With decades of specialization and experience, Stern plays a central role in transforming electronic faucets from hygienic & water saving products for public bathrooms into reliable, safe and green products for public *and* residential use. Stern is committed to providing smart water delivery solutions that maximize water savings without sacrificing the comfort and convenience of the user experience or the durability and style of the products.

PICTOGRAM KEY



LEED RATING

LEED RATING

Ideal product to maximize LEED credits.



LEAD FREE

LEAD FREE

Maximum lead content of the product is a weighted average of 0.25%



LED COLORS

LED COLORS

This product features a ring illumination based on LED. Sample colors available (other colors available upon request)

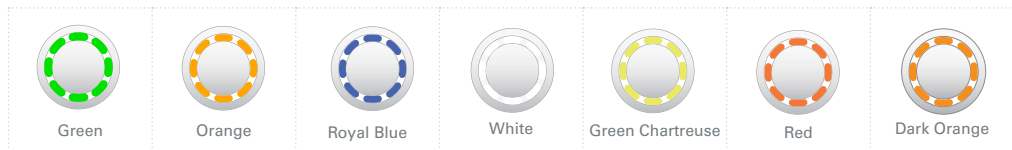

IRON FRAME AVAILABLE

IRON FRAME AVAILABLE

This product can be ordered as a kit that includes an iron frame making its installation easier than ever.



STERN MEDICAL

STERN MEDICAL

This product belongs to the Stern Medical range and was specially designed for the needs of the healthcare sector.



PREVENT SCALDING

PREVENTS SCALDING

This product includes thermostatic technology. Often, injuries while washing hands or in the shower are caused by slips and falls in reaction to a sudden increase or decrease in water temperature. The termination of hot water flow, immediately eliminates the instinctive but dangerous reaction to move quickly away from a too hot or too cold water stream, helping to prevent scalding.



WAVE & PROX OPTIONS

WAVE & PROX

This product includes a proximity detection sensor or a wave activation sensor that allows activation by placing a hand within a close distance from the sensor eye.

INDEX



LAVATORY
FAUCETS
1-34



WALL MOUNTED
FAUCETS
35-56



SOAP DISPENSERS
57-82



BEHIND THE
MIRROR
83-90



SHOWERS
91-106



URINALS & TOILETS
107-126



IRON FRAME SETS
127-134



COMPONENTS
& ACCESSORIES
135-145

LAVATORY FAUCETS

1-34



TRENDY SERIES **3-8**



EXTREME SERIES **9-14**



ELITE SERIES **15-16**



SMART SERIES **17-18**



GREEN SERIES **19-22**



TOUCH FREE **23**



TOUCH SERIES **24**



TUBULAR DM **25**



EASY SERIES **26**



SWAN SERIES **27-28**



CLASSIC SERIES **29-30**



CONDOR SERIES **31**



DOLPHIN SERIES **32**



COOL SERIES **33-34**

TRENDY SERIES

Electronic lavatory faucet operated by IR sensor.

Series includes options for cold or premixed water as well as hot and cold water, long spout, tall versions for counter top sinks and ring illumination models.

Advantages:

- Drastically reduces water consumption
- No physical contact. Helps to protect users against cross contamination
- Sensor settings adjustable by remote control
- Easy installation
- Internal solenoid valve
- Matching IR operated soap dispenser



LEED RATING











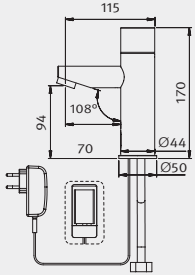

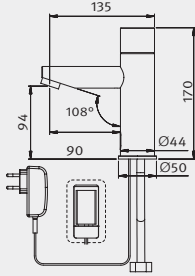

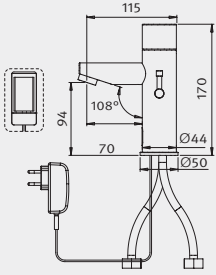

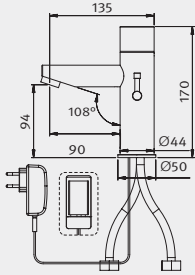

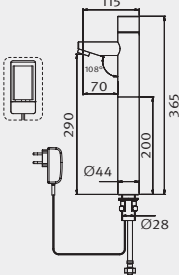

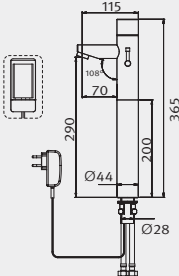
LED COLORS

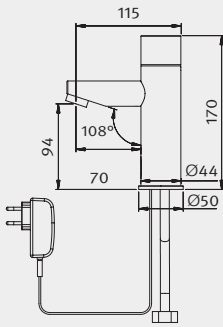

WATER SAVING OPTIONS

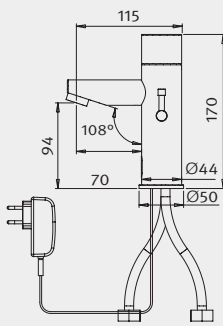
6 LPM	1.58 GPM	SSR PCA Stream
4 LPM	1 GPM	PCA Spray
3 LPM	0.8 GPM	PCA Spray
1.89 LPM	0.5 GPM	PCA Spray
1.3 LPM	0.35 GPM	PCA Spray

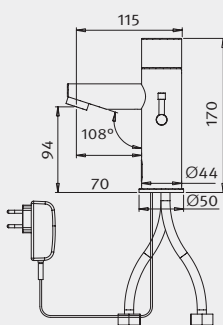
PICTURE	PRODUCT NAME	MODEL FEATURES	POWER SUPPLY	CODE NUMBER	DRAWING
	TRENDY B	Standard	9V Battery	239000	
	TRENDY E		9V Transformer	239100	
	TRENDY LB	Long spout 90mm	9V Battery	239400	
	TRENDY LE		9V Transformer	239500	
	TRENDY 1000 B	Mixer to adjust water temperature	9V Battery	239200	
	TRENDY 1000 E		9V Transformer	239300	
	TRENDY 1000 LB	Mixer to adjust water temperature. Long spout 90mm	9V Battery	239600	
	TRENDY 1000 LE		9V Transformer	239700	
	TRENDY PLUS B	Tall version for counter top wash basins	9V Battery	239050	
	TRENDY PLUS E		9V Transformer	239150	
	TRENDY 1000 PLUS B	Tall version for counter top wash basins. Mixer to adjust water temperature	9V Battery	239250	
	TRENDY 1000 PLUS E		9V Transformer	239350	

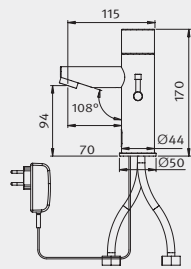
PICTURE	PRODUCT NAME	MODEL FEATURES	POWER SUPPLY	CODE NUMBER	DRAWING
	TRENDY BRE	Permanent ring illumination. When a user places his hands within the sensor range, the ring of light blinks while water runs out of the faucet.	9V Transformer	239105	
	TRENDY 1000 BRE	Mixer to adjust water temperature Permanent ring illumination. When a user places his hands within the sensor range, the ring of light blinks while water runs out of the faucet.	9V Transformer	239305	
	TRENDY HABITAT E	Mixer to adjust water temperature Alternative touch operation and ring illumination. Includes a piezo element integrated in the faucet cap for alternative touch operation, used to fill in the sink or a pan. When a user touches the piezo area a flow cycle of 20 seconds is completed. The ring of light will blink while water runs out of the faucet.	9V Transformer	239340	
	TRENDY TEMPRA E	Mixer to adjust water temperature. Includes both touch free and touch operations. In addition, these models include a second sensor located inside the faucet body designed for real temperature indication. This second sensor senses the temperature of the water used, and commands the ring of light accordingly. The result is a gradual transition of colors from Blue to Red, that intuitively indicates the real temperature of the water and helps to prevent scalding.	9V Transformer	239410	

TRENDY TOUCH SERIES

Electronic lavatory faucet operated by touch.

Features a Piezo element integrated in the faucet cap. Series includes options for cold or premixed water as well as hot and cold water. Includes ring illuminated versions.

Advantages:

- Drastically reduces water consumption
- No moving parts, ideal for heavy duty areas
- Non hold open feature
- More possibilities to save water: the water flow can be stopped in the middle of the cycle
- Stable and accurate water flow that can be changed on site
- Easy installation
- Internal solenoid valve
- Matching IR operated soap dispenser



LEED RATING



LEED COLORS

WATER SAVING OPTIONS

6 LPM	1.58 GPM	SSR PCA Stream
4 LPM	1 GPM	PCA Spray
3 LPM	0.8 GPM	PCA Spray
1.89 LPM	0.5 GPM	PCA Spray
1.3 LPM	0.35 GPM	PCA Spray

PICTURE	PRODUCT NAME	MODEL FEATURES	POWER SUPPLY	CODE NUMBER	DRAWING
	TRENDY TOUCH B	Standard	9V Battery	239020	
	TRENDY TOUCH E		9V Transformer	239120	
	TRENDY TOUCH 1000 B	Mixer to adjust water temperature	9V Battery	239220	
	TRENDY TOUCH 1000 E		9V Transformer	239320	
	TRENDY TOUCH BRE	Features a ring of light. When a user touches the designated area in the middle of the ring of light a flow cycle of 8 seconds is completed. The ring of light blinks while water runs out of the faucet. If the user does not need more water, he can touch the piezo area again to stop the water flow before the default time has passed, thus, saving more water.	9V Transformer	239130	
	TRENDY TOUCH 1000 BRE	Mixer to adjust water temperature. Features a ring of light. When a user touches the designated area in the middle of the ring of light a flow cycle of 8 seconds is completed. The ring of light blinks while water runs out of the faucet. If the user does not need more water, he can touch the piezo area again to stop the water flow before the default time has passed, thus, saving more water.	9V Transformer	239330	

TRENDY T SERIES

Electronic lavatory faucet operated by IR sensor.

Features an integrated thermostatic mixer for an anti scalding operation and temperature control.

Advantages:

- Lead free
- Thermostatic control for optimum temperature
- Internal stopper allows setting the maximum temperature according to the project requirements
- No physical contact. Helps to protect users against cross contamination and Legionnaire's disease
- Ideal for the healthcare sector
- Easy installation
- Internal solenoid valve
- Matching IR operated soap dispenser

TEMPERATURE FEATURES

HOT LIMIT STOPPER - Mechanical mechanism for built in maximum temperature control at 48.9°C (120°F), factory set. Other values available upon request

COMFORT STOP - Allows limiting the hot water temperature the user can reach, from 38°C (100.4°F) to 48.9°C (120°F).

FIXED TEMPERATURE - Allows the technical staff to set a stable temperature and fix the faucet cap to the specific temperature only.



WATER SAVING OPTIONS		
6 LPM	1.58 GPM	SSR PCA Stream
4 LPM	1 GPM	PCA Spray
3 LPM	0.8 GPM	PCA Spray
1.89 LPM	0.5 GPM	PCA Spray
1.3 LPM	0.35 GPM	PCA Spray



LEED RATING



PREVENT SCALDING



STERN MEDICAL

PICTURE	PRODUCT NAME	MODEL FEATURES	POWER SUPPLY	CODE NUMBER	DRAWING
	TRENDY TB	Integrated thermostatic mixer to adjust water temperature	9V Battery	236930	
	TRENDY TE		9V Transformer	236935	



METAL THERMOSTATIC MIXING HANDLE



THERMOSTATIC CARTRIDGE INTEGRATED WITH A HOT LIMIT STOPPER AND COMFORT STOP



FULL BRASS FAUCET BODY

SSR PCA STREAM AERATOR
(for more options see water saving options)

IR SENSOR WITH:

- a. 15 seconds run flow time
- b. 7 (seven) minutes hot water recirculation function operated by remote control
- c. Sensor functions adjustable by remote control

IP67 BATTERY BOX

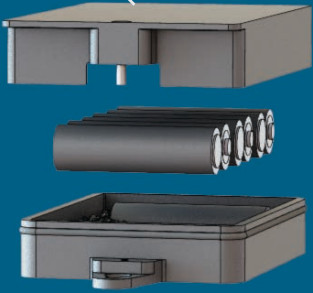

SOLENOID VALVE



FAUCET INSERT & FLEXIBLE PIPES

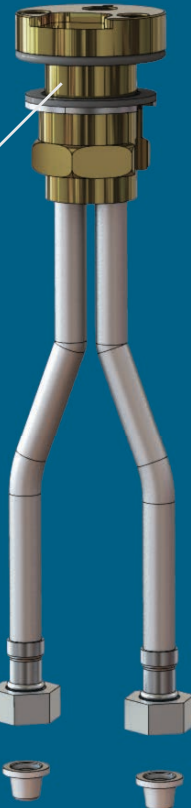

REMOTE CONTROL



EXTREME SERIES

Electronic lavatory faucet operated by IR sensor.

Series includes options for cold or premixed water as well as hot and cold water, long spout and tall versions for counter top sinks.

Advantages:

- Drastically reduces water consumption
- No physical contact. Helps to protect users against cross contamination
- Minimalist design with an emotional appeal, perfectly balanced due to its tempting rounded edges and smooth transitions
- Sensor settings adjustable by remote control
- Easy installation
- Internal solenoid valve
- Matching IR operated soap dispenser



LEED RATING











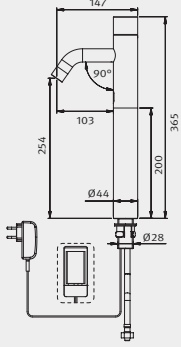

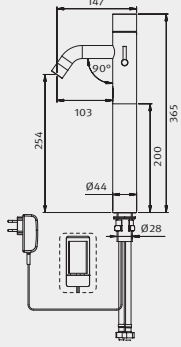

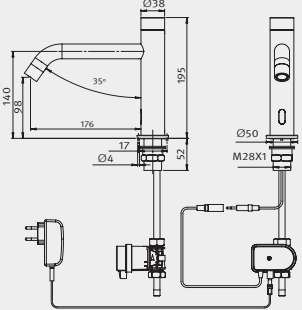
LED COLORS

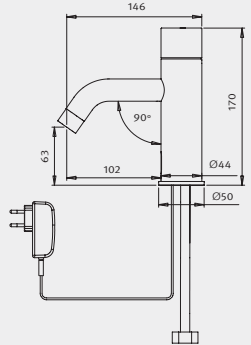

WATER SAVING OPTIONS		
6 LPM	1.58 GPM	SSR PCA Stream
4 LPM	1 GPM	PCA Spray
3 LPM	0.8 GPM	PCA Spray
1.89 LPM	0.5 GPM	PCA Spray
1.3 LPM	0.35 GPM	PCA Spray

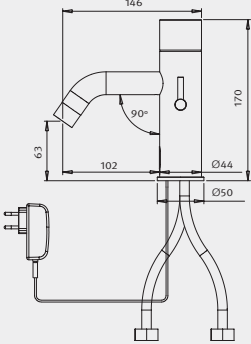
PICTURE	PRODUCT NAME	MODEL FEATURES	POWER SUPPLY	CODE NUMBER	DRAWING
	EXTREME B	Standard	9V Battery	237200	
	EXTREME E		9V Transformer	237300	
	EXTREME 1000 B	Mixer to adjust water temperature	9V Battery	237100	
	EXTREME 1000 E		9V Transformer	237000	

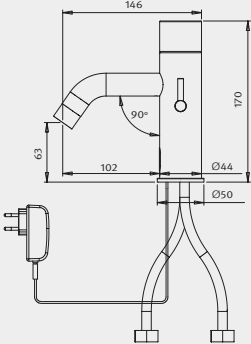
PICTURE	PRODUCT NAME	MODEL FEATURES	POWER SUPPLY	CODE NUMBER	DRAWING
	EXTREME PLUS B	Tall version for counter top wash basins	9V Battery	237250	
	EXTREME PLUS E		9V Transformer	237350	
	EXTREME 1000 PLUS B	Tall version for counter top wash basins.	9V Battery	237150	
	EXTREME 1000 PLUS E	Mixer to adjust water temperature	9V Transformer	237050	
	EXTREME HLB	Long spout 176mm. Body diameter Ø38. Dual power input box. When powered by a 9V transformer features an integrated backup system to be used with a 9V Lithium Battery, which enables the product to be used normally in case of a power failure.	9V Battery	237317	
	EXTREME HLE		9V Transformer	237316	

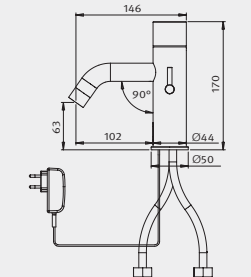
PICTURE	PRODUCT NAME	MODEL FEATURES	POWER SUPPLY	CODE NUMBER	DRAWING
	<p>EXTREME BRE</p>	<p>Standard</p> <p>Features a permanent ring illumination. When a user places his hands within the sensor range, the ring of light blinks while water runs out of the faucet.</p>	<p>9V Transformer</p>	<p>237305</p>	
	<p>EXTREME 1000 BRE</p>	<p>Mixer to adjust water temperature</p> <p>Features a permanent ring illumination. When a user places his hands within the sensor range, the ring of light blinks while water runs out of the faucet.</p>	<p>9V Transformer</p>	<p>237005</p>	
	<p>EXTREME HABITAT E</p>	<p>Mixer to adjust water temperature.</p> <p>Alternative touch operation.</p> <p>Includes a piezo element integrated in the faucet cap for alternative touch operation, used to fill in the sink or a pan.</p> <p>When a user touches the piezo area a flow cycle of 20 seconds is completed. The ring of light will blink while water runs out of the faucet.</p> <p>Ring illumination</p>	<p>9V Transformer</p>	<p>237040</p>	
	<p>EXTREME TEMPRA E</p>	<p>Mixer to adjust water temperature.</p> <p>Includes both touch free and touch operations.</p> <p>In addition, these models include a second sensor located inside the faucet body designed for real temperature indication.</p> <p>This second sensor senses the temperature of the water used, and commands the ring of light accordingly.</p> <p>The result is a gradual transition of colors from Blue to Red, that intuitively indicates the real temperature of the water and helps to prevent scalding.</p>	<p>9V Transformer</p>	<p>237070</p>	

EXTREME LF SERIES

Electronic lavatory faucet operated by IR sensor.





Lead free faucet for cold or premixed water with a concealed sensor integrated into the spout.

Advantages:

- Drastically reduces water consumption
- No physical contact. Helps to protect users against cross contamination
- Minimalist design with an emotional appeal, perfectly balanced due to its tempting rounded edges and smooth transitions
- Sensor settings adjustable by remote control
- Easy installation
- The stainless steel AISI316 version is especially valued for its anti-corrosion properties in coastal environments.

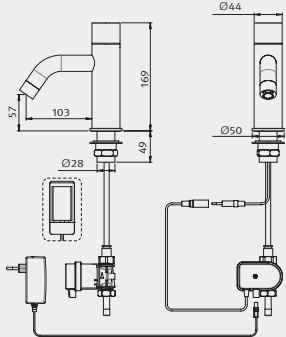

WATER SAVING OPTIONS		
4 LPM	1 GPM	Honeycomb TT
1.89 LPM	0.5 GPM	PCA Spray

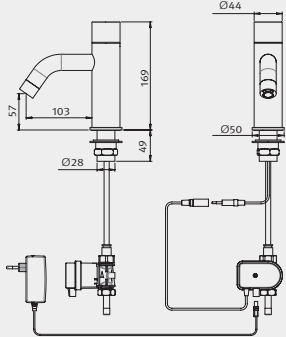
PICTURE	PRODUCT NAME	MODEL FEATURES	POWER SUPPLY	CODE NUMBER	DRAWING
 	EXTREME LFB	Lead free version with concealed sensor at the spout.	9V Battery	237820	
	EXTREME LFE		9V Transformer	237810	
 	EXTREME LFE AISI316	Stainless steel AISI 316 body. Ideal for medical and coastal environments	9V Transformer	237811	

EXTREME TOUCH SERIES

Electronic lavatory faucet operated by touch.

Features a Piezo element integrated in the faucet cap. Series includes options for cold or premixed water as well as hot and cold water. Includes ring illuminated versions.

Advantages:

- Drastically reduces water consumption
- No moving parts, ideal for heavy duty areas
- Non hold open feature
- More possibilities to save water: the water flow can be stopped in the middle of the cycle
- Stable and accurate water flow that can be changed on site
- Easy installation
- Internal solenoid valve
- Matching IR operated soap dispenser



LEED RATING



LEED COLORS



WATER SAVING OPTIONS		
6 LPM	1.58 GPM	SSR PCA Stream
4 LPM	1 GPM	PCA Spray
3 LPM	0.8 GPM	PCA Spray
1.89 LPM	0.5 GPM	PCA Spray
1.3 LPM	0.35 GPM	PCA Spray

PICTURE	PRODUCT NAME	MODEL FEATURES	POWER SUPPLY	CODE NUMBER	DRAWING
	EXTREME TOUCH B	Standard	9V Battery	237210	
	EXTREME TOUCH E		9V Transformer	237310	
	EXTREME TOUCH 1000 B	Mixer to adjust water temperature	9V Battery	237110	
	EXTREME TOUCH 1000 E		9V Transformer	237010	
	EXTREME TOUCH BRE	Features a ring of light. When a user touches the designated area in the middle of the ring of light a flow cycle of 8 seconds is completed. The ring of light blinks while water runs out of the faucet. If the user does not need more water, he can touch the piezo area again to stop the water flow before the default time has passed, thus, saving more water.	9V Transformer	237320	
	EXTREME TOUCH 1000 BRE	Mixer to adjust water temperature. Features a ring of light. When a user touches the designated area in the middle of the ring of light a flow cycle of 8 seconds is completed. The ring of light blinks while water runs out of the faucet. If the user does not need more water, he can touch the piezo area again to stop the water flow before the default time has passed, thus, saving more water.	9V Transformer	237020	



ELITE SERIES

Electronic lavatory faucet operated by IR sensor.

Series includes options for cold or premixed water as well as hot and cold water, long spout and tall versions for counter top sinks.

Advantages:

- Drastically reduces water consumption
- No physical contact. Helps to protect users against cross contamination
- Minimalist design with an emotional appeal, perfectly balanced due to its tempting rounded edges and smooth transitions.
- Sensor settings adjustable by remote control
- Easy installation
- Internal solenoid valve
- Matching IR operated soap dispenser



WATER SAVING OPTIONS		
6 LPM	1.58 GPM	SSR PCA Stream
4 LPM	1 GPM	PCA Spray
3 LPM	0.8 GPM	PCA Spray
1.89 LPM	0.5 GPM	PCA Spray
1.3 LPM	0.35 GPM	PCA Spray

PICTURE	PRODUCT NAME	MODEL FEATURES	POWER SUPPLY	CODE NUMBER	DRAWING
	ELITE B	Standard	9V Battery	236300	
	ELITE E		9V Transformer	236400	
	ELITE 1000 B	Mixer to adjust water temperature	9V Battery	236700	
	ELITE 1000 E		9V Transformer	236800	
	ELITE LB	Extra long spout 138mm	9V Battery	236500	
	ELITE LE		9V Transformer	236600	

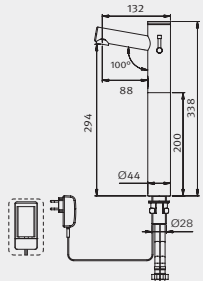
PICTURE	PRODUCT NAME	MODEL FEATURES	POWER SUPPLY	CODE NUMBER	DRAWING
	ELITE 1000 LB	Mixer to adjust water temperature. Extra long spout 138mm	9V Battery	236550	
	ELITE 1000 LE		9V Transformer	236650	
	ELITE PLUS B	Tall version for counter top wash basins	9V Battery	236350	
	ELITE PLUS E		9V Transformer	236450	
	ELITE 1000 PLUS B	Tall version for counter top wash basins. Mixer to adjust water temperature	9V Battery	236750	
	ELITE 1000 PLUS E		9V Transformer	236850	
	ELITE 1000 B with Technician's Mixer	Mixer to adjust water temperature and technician's mixer option Allows removing the mixing handle so that the maintenance staff can adjust the water temperature without giving that possibility to the end user.	9V Battery	236720	
	ELITE 1000 E with Technician's Mixer		9V Transformer	236805	

SMART SERIES

Electronic lavatory faucet operated by IR sensor.

Series includes options for cold or premixed water as well as hot and cold water, long spout and tall versions for counter top sinks.

Advantages:

- Drastically reduces water consumption
- No physical contact. Helps to protect users against cross contamination
- Sensor settings adjustable by remote control
- Easy installation
- Internal solenoid valve



WATER SAVING OPTIONS		
6 LPM	1.58 GPM	SSR PCA Stream
4 LPM	1 GPM	PCA Spray
3 LPM	0.8 GPM	PCA Spray
1.89 LPM	0.5 GPM	PCA Spray
1.3 LPM	0.35 GPM	PCA Spray



PICTURE	PRODUCT NAME	MODEL FEATURES	POWER SUPPLY	CODE NUMBER	DRAWING
	SMART B	Standard	9V Battery	235100	
	SMART E		9V Transformer	235200	
	SMART 1000 B	Mixer to adjust water temperature	9V Battery	235500	
	SMART 1000 E		9V Transformer	235600	
	SMART LB	Long spout 90mm	9V Battery	235110	
	SMART LE		9V Transformer	235210	
	SMART 1000 LB	Long spout 90mm Mixer to adjust water temperature.	9V Battery	235510	
	SMART 1000 LE		9V Transformer	235610	
	SMART PLUS B	Tall version for counter top wash basins	9V Battery	235150	
	SMART PLUS E		9V Transformer	235250	
	SMART 1000 PLUS B	Tall version for counter top wash basins. Mixer to adjust water temperature	9V Battery	235550	
	SMART 1000 PLUS E		9V Transformer	235650	

GREEN SERIES

Electronic lavatory faucet operated by IR sensor.

Series includes options for cold or premixed water as well as hot and cold water. Includes ring illuminated versions (electricity operated only).

Advantages:

- Drastically reduces water consumption
- No physical contact. Helps to protect users against cross contamination
- Timeless design based on elementary forms
- Lead Free
- Versions with internal battery for theft prevention
- Sensor settings adjustable by remote control
- Easy installation
- Internal solenoid valve
- Matching IR operated soap dispenser



LEAD FREE



LEED RATING



LEED COLORS

WATER SAVING OPTIONS		
6 LPM	1.58 GPM	SSR PCA Stream
4 LPM	1 GPM	PCA Spray
3 LPM	0.8 GPM	PCA Spray
1.89 LPM	0.5 GPM	PCA Spray
1.3 LPM	0.35 GPM	PCA Spray



PICTURE	PRODUCT NAME	MODEL FEATURES	POWER SUPPLY	CODE NUMBER	DRAWING
	GREEN AB1953	Internal Battery	9V Battery	225901	
	GREEN B AB1953	Standard	9V Battery	225951	
	GREEN E AB1953		9V Transformer	225941	
	GREEN BRE AB1953	Ring Illumination Features a permanent ring illumination. When a user places his hands within the sensor range, the ring of light blinks while water runs out of the faucet.	9V Transformer	225921	
	GREEN 1000 AB1953	Mixer to adjust water temperature. Internal Battery	9V Battery	225801	
	GREEN 1000 B AB1953	Mixer to adjust water temperature	9V Battery	225871	
	GREEN 1000 E AB1953		9V Transformer	225821	
	GREEN 1000 BRE AB1953	Mixer to adjust water temperature. Features a permanent ring illumination. When a user places his hands within the sensor range, the ring of light blinks while water runs out of the faucet.	9V Transformer	225891	

GREEN TIME SERIES

Electronic lavatory faucet operated by touch.

Features a Piezo element integrated in the faucet cap. Series includes options for cold or premixed water as well as hot and cold water. Includes ring illuminated versions (electricity operated only).

Advantages:

- Drastically reduces water consumption
- Timeless design based on elementary forms
- Lead Free
- No moving parts, ideal for heavy duty areas
- Non hold open feature
- More possibilities to save water: the water flow can be stopped in the middle of the cycle
- Stable and accurate water flow that can be changed on site
- Easy installation
- Internal solenoid valve
- Matching IR operated soap dispenser



LEED RATING











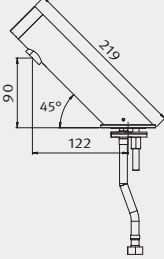

LED COLORS

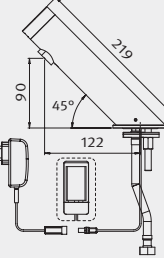

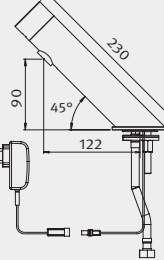
WATER SAVING OPTIONS

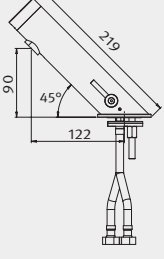
6 LPM	1.58 GPM	SSR PCA Stream
4 LPM	1 GPM	PCA Spray
3 LPM	0.8 GPM	PCA Spray
1.89 LPM	0.5 GPM	PCA Spray
1.3 LPM	0.35 GPM	PCA Spray

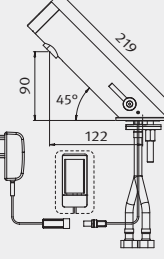

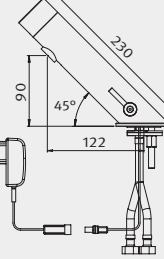
PICTURE	PRODUCT NAME	MODEL FEATURES	POWER SUPPLY	CODE NUMBER	DRAWING
	GREEN TIME AB1953	Internal Battery	9V Battery	225911	
	GREEN TIME B AB1953	Standard	9V Battery	225981	
	GREEN TIME E AB1953		9V Transformer	225971	
	GREEN TIME BRE AB1953	Ring Illumination Features a permanent ring illumination. When a user places his hands within the sensor range, the ring of light blinks while water runs out of the faucet.	9V Transformer	225926	
	GREEN TIME 1000 AB1953	Mixer to adjust water temperature. Internal Battery	9V Battery	225811	
	GREEN TIME 1000 B AB1953	Mixer to adjust water temperature	9V Battery	225881	
	GREEN TIME 1000 E AB1953		9V Transformer	225831	
	GREEN TIME 1000 BRE AB1953	Mixer to adjust water temperature. Features a permanent ring illumination. When a user places his hands within the sensor range, the ring of light blinks while water runs out of the faucet.	9V Transformer	225836	

TOUCH FREE SERIES

Electronic lavatory faucet operated by IR sensor.
Includes options for cold or premixed water.

Advantages:

- Drastically reduces water consumption
- No physical contact. Helps to protect users against cross contamination
- Lead Free
- Sensor settings adjustable by remote control
- Easy installation
- Matching IR operated soap dispenser



LEAD FREE



LEED RATING



WATER SAVING OPTIONS

5 LPM	1.32 GPM	Cache
1.89 LPM	0.5 GPM	PCA Spray

PICTURE	PRODUCT NAME	MODEL FEATURES	POWER SUPPLY	CODE NUMBER	DRAWING
	TOUCH FREE B AB1953	Standard	9V Battery	225610	
	TOUCH FREE E AB1953		9V Transformer	225710	

TOUCH SERIES

Electronically operated self-closing faucet operated by touch.

Features a Piezo element integrated in the faucet cap.

For cold or premixed water.

Advantages:

- Drastically reduces water consumption
- No moving parts, ideal for heavy duty areas
- Non hold open feature
- More possibilities to save water: the water flow can be stopped in the middle of the cycle
- Stable and accurate water flow that can be changed on site
- Easy installation
- Matching IR operated soap dispenser



WATER SAVING OPTIONS		
5 LPM	1.32 GPM	Cache
1.89 LPM	0.5 GPM	PCA Spray



PICTURE	PRODUCT NAME	MODEL FEATURES	POWER SUPPLY	CODE NUMBER	DRAWING
	TOUCH B	Standard	9V Battery	225100	
	TOUCH E		9V Transformer	225200	
	TOUCH BRE	Features a permanent ring illumination. When a user places his hands within the sensor range, the ring of light blinks while water runs out of the faucet.	9V Transformer	225500	

TUBULAR DM SERIES

Electronic lavatory faucet operated by IR sensor.

For cold or premixed water.

Advantages:

- Drastically reduces water consumption
- No physical contact. Helps to protect users against cross contamination
- Versions with internal battery for theft prevention
- Sensor settings adjustable by remote control
- Easy installation
- Matching IR operated soap dispenser



WATER SAVING OPTIONS		
6 LPM	1.58 GPM	SSR PCA Stream
4 LPM	1 GPM	PCA Spray
3 LPM	0.8 GPM	PCA Spray
1.89 LPM	0.5 GPM	PCA Spray
1.3 LPM	0.35 GPM	PCA Spray

PICTURE	PRODUCT NAME	MODEL FEATURES	POWER SUPPLY	CODE NUMBER	DRAWING
	TUBULAR DMB	Standard Optional: IP67 Dual power input box that allows the faucet to be used with a 9V battery or a 9V transformer. Tubular DM could be also be powered by a 9V transformer and an integrated backup system to be used with a 9V Lithium battery, which enables the product to be used normally in case of a power failure.	9V Battery	350700	
	TUBULAR DME		9V Transformer	350750	

EASY SERIES

Electronic lavatory faucet operated by IR sensor.

Series includes options for cold or premixed water as well as hot and cold water.

Advantages:

- Drastically reduces water consumption
- No physical contact. Helps to protect users against cross contamination
- One piece construction, ideal for heavy duty areas
- Sensor settings adjustable by remote control
- Easy installation
- Matching IR operated soap dispenser



LEED RATING

WATER SAVING OPTIONS		
6 LPM	1.58 GPM	SSR PCA Stream
4 LPM	1 GPM	PCA Spray
3 LPM	0.8 GPM	PCA Spray
1.89 LPM	0.5 GPM	PCA Spray
1.3 LPM	0.35 GPM	PCA Spray

PICTURE	PRODUCT NAME	MODEL FEATURES	POWER SUPPLY	CODE NUMBER	DRAWING
	EASY B	Standard	9V Battery	246010	
	EASY E		9V Transformer	246020	
	EASY 1000 B	Mixer to adjust water temperature with technician's mixer option that allows removing the mixing handle so that the maintenance staff can adjust the water temperature without giving that possibility to the end user.	9V Battery	246050	
	EASY 1000 E		9V Transformer	246060	

SWAN SERIES

Electronic lavatory faucet operated by IR sensor.

Series includes options for cold or premixed water as well as hot and cold water.

Advantages:

- Drastically reduces water consumption
- No physical contact. Helps to protect users against cross contamination
- Lead free (Except for BM versions)
- One piece construction, ideal for heavy duty areas
- Versions with internal battery for theft prevention
- Sensor settings adjustable by remote control
- Easy installation
- Internal solenoid valve
- Matching IR operated soap dispenser



LEED RATING

WATER SAVING OPTIONS		
6 LPM	1.58 GPM	SSR PCA Stream
4 LPM	1 GPM	PCA Spray
3 LPM	0.8 GPM	PCA Spray
1.89 LPM	0.5 GPM	PCA Spray
1.3 LPM	0.35 GPM	PCA Spray



PICTURE	PRODUCT NAME	MODEL FEATURES	POWER SUPPLY	CODE NUMBER	DRAWING
	SWAN 1010 AB1953	Internal Battery	9V Battery	250220	
	SWAN 1010 B AB1953	Standard	9V Battery	250310	
	SWAN 1010 E AB1953		9V Transformer	250420	
	SWAN 1000 AB1953	Internal Battery	9V Battery	252210	
	SWAN 1000 B AB1953	Standard	9V Battery	252310	
	SWAN 1000 E AB1953		9V Transformer	252420	
	SWAN 1000 BM	Override handle to enable manual operation Allows the user to operate the faucet by the IR sensor without physical contact or manually using the left handle, operating the faucet the conventional way.	9V Battery	252301	
	SWAN 1000 EM		9V Transformer	252401	

CLASSIC SERIES

Electronic lavatory faucet operated by IR sensor.

Series includes options for cold or premixed water as well as hot and cold water.

Advantages:

- Drastically reduces water consumption
- No physical contact. Helps to protect users against cross contamination
- Robust, one piece construction, ideal for heavy duty areas
- Versions with internal battery for theft prevention
- Sensor settings adjustable by remote control
- Easy installation
- Internal solenoid valve











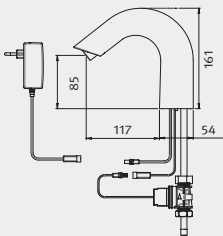

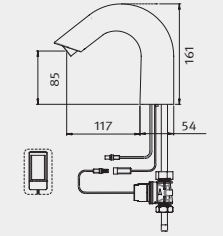
LEED RATING

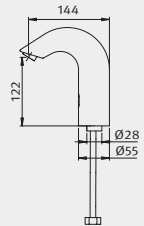

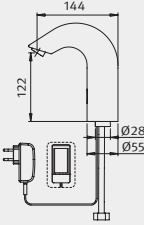
WATER SAVING OPTIONS		
6 LPM	1.58 GPM	SSR PCA Stream
4 LPM	1 GPM	PCA Spray
3 LPM	0.8 GPM	PCA Spray
1.89 LPM	0.5 GPM	PCA Spray
1.3 LPM	0.35 GPM	PCA Spray

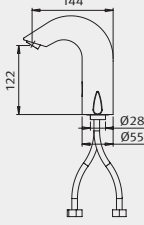

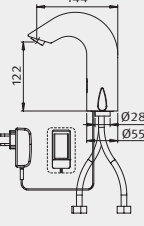
PICTURE	PRODUCT NAME	MODEL FEATURES	POWER SUPPLY	CODE NUMBER	DRAWING
NEW 	CLASSIC CS B	Internal Battery Concealed sensor for optimal quicker response from the sensor	9V Battery	293100	
NEW 	CLASSIC CS E	Internal Battery Concealed sensor for optimal quicker response from the sensor	9V Transformer	293200	
	CLASSIC AB1953	Internal Battery	9V Battery	291010	
	CLASSIC B AB1953	Standard	9V Battery	291110	
	CLASSIC E AB1953		9V Transformer	291210	
	CLASSIC 1000 AB1953	Internal Battery	9V Battery	292020	
	CLASSIC 1000 B AB1953	Standard	9V Battery	292120	
	CLASSIC 1000 E AB1953		9V Transformer	292230	

CONDOR SERIES

Electronic lavatory faucet operated by IR sensor.

For cold or premixed water.

Integrated panel versions.

Advantages:

- Drastically reduces water consumption
- No physical contact. Helps to protect users against cross contamination
- Lead Free
- Versions with integrated panel to cover old installation holes
- Sensor settings adjustable by remote control
- Easy installation



WATER SAVING OPTIONS		
6 LPM	1.58 GPM	SSR PCA Stream
4 LPM	1 GPM	PCA Spray
3 LPM	0.8 GPM	PCA Spray
1.89 LPM	0.5 GPM	PCA Spray
1.3 LPM	0.35 GPM	PCA Spray

PICTURE	PRODUCT NAME	MODEL FEATURES	POWER SUPPLY	CODE NUMBER	DRAWING
	CONDOR 1010	Standard IP67 Dual power input box that allows the faucet to be used with a 9V battery or a 9V transformer. Condor 1010 can be also be powered by a 9V transformer and an integrated backup system to be used with a 9V Lithium battery, which enables the product to be used normally in case of a power failure.	9V Battery	210100	
	CONDOR 1010 E		9V Transformer	210300	
	CONDOR	Integrated panel IP67 Dual power input box that allows the faucet to be used with a 9V battery or a 9V transformer. Condor can be also be powered by a 9V transformer and an integrated backup system to be used with a 9V Lithium battery, which enables the product to be used normally in case of a power failure.	9V Battery	210000	
	CONDOR E		9V Transformer	210200	

DOLPHIN SERIES

Electronic lavatory faucet operated by IR sensor.

Series includes options for cold or premixed water as well as hot and cold water.

Advantages:

- Drastically reduces water consumption
- No physical contact. Helps to protect users against cross contamination
- Ideal for the healthcare sector.
- Sensor settings adjustable by remote control
- Easy installation
- Internal solenoid valve (Dolphin 1000 models only)



LEED RATING



STERN MEDICAL



WATER SAVING OPTIONS		
6 LPM	1.58 GPM	SSR PCA Stream
4 LPM	1 GPM	PCA Spray
3 LPM	0.8 GPM	PCA Spray
1.89 LPM	0.5 GPM	PCA Spray
1.3 LPM	0.35 GPM	PCA Spray

PICTURE	PRODUCT NAME	MODEL FEATURES	POWER SUPPLY	CODE NUMBER	DRAWING
	DOLPHIN FB	Standard	9V Battery	270170	
	DOLPHIN FE		9V Transformer	270180	
	DOLPHIN 1000 FB	Mixer to adjust water temperature Internal solenoid	9V Battery	270320	
	DOLPHIN 1000 FE		9V Transformer	270330	
	DOLPHIN GB	Gooseneck tall spout	9V Battery	270120	
	DOLPHIN GE		9V Transformer	270220	

COOL SERIES

Electronically operated self closing glass filler faucet operated by touch.
Operated by a Piezo element integrated in the faucet body.

Advantages:

- Drastically reduces water consumption
- No moving parts, ideal for heavy duty areas
- Non hold open feature
- Lead free
- Easy touch activation to allow use by young children, elderly and disabled people
- Ideal for drinking fountains, coolers and water stations
- Stable and accurate water flow that can be changed on site to fill in a specific glass or bottle size
- Designed for bars, restaurants and commercial food service kitchens
- Easy installation



PICTURE	PRODUCT NAME	MODEL FEATURES	POWER SUPPLY	CODE NUMBER	DRAWING
	COOL B	Long reach spout	9V Battery	280115	
	COOL E		9V Transformer	280110	
	COOL BRE	Long reach spout. Features a permanent ring illumination. When a user places his hands within the sensor range, the ring of light blinks while water runs out of the faucet.	9V Transformer	280100	
	COOL GB	Standard	9V Battery	280125	
	COOL GE		9V Transformer	280130	
	COOL GBRE	Ring Illumination Features a permanent ring illumination. When a user places his hands within the sensor range, the ring of light blinks while water runs out of the faucet.	9V Transformer	280120	

WALL MOUNTED FAUCETS

35-56



D28 SERIES 37-39



MALMO SERIES 40



TUBULAR SERIES 41-46



EXTREME CS SERIES 47-48



QUADRAT SERIES 49-50

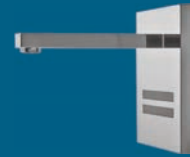

NARA Q 51



CUBICA SERIES 51



APOLLO AL 52



MEDICAL SERIES 53-54



APOLLO FREE 55



WASHFREE 1000 55



PROX, WAVE & TOUCH SOLUTIONS 56

D28 SERIES

Electronic wall mounted faucet operated by IR sensor.
For cold or premixed water.

Advantages:

- Drastically reduces water consumption
- No physical contact. Helps to protect users against cross contamination
- Lead free (D28 & D28 prox models)
- Suits any washroom due to its minimalist design
- Sensor settings adjustable by remote control
- Easy installation
- Matching IR operated soap dispenser



LEED RATING









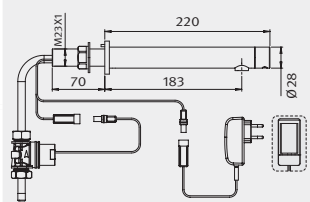

IRON FRAME AVAILABLE

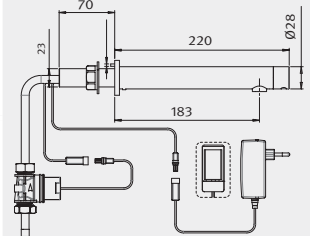
WATER SAVING OPTIONS

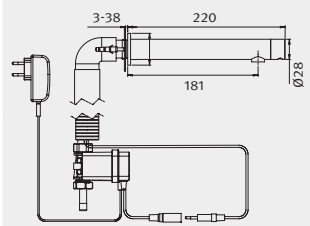
5 LPM	1.32 GPM	Honeycomb TT
1.89 LPM	0.5 GPM	PCA Spray

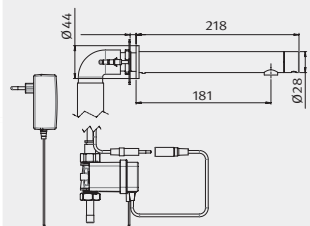

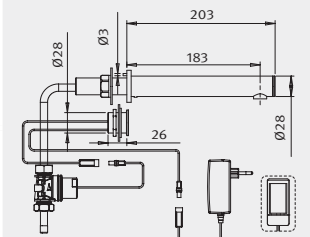
PICTURE	PRODUCT NAME	MODEL FEATURES	POWER SUPPLY	CODE NUMBER	DRAWING
	D28 B	Concealed installation in dry walls. Iron frame available (see page 127)	9V Battery	352000	
	D28 E		9V Transformer	352100	
NEW 	D28 AISI316	Stainless steel 316 body. Concealed installation in dry walls. Iron frame available (see page 127)	9V Battery	352130	
	D28 E AISI316		9V Transformer	352120	
	D28 DUAL POWER B	Concealed installation in dry walls as well as concrete, brick walls. Dual power input box. When powered by a 9V transformer features an integrated backup system to be used with a 9V Lithium Battery, which enables the product to be used normally in case of a power failure.	9V Battery	352300	
	D28 DUAL POWER E		Iron Frame available (see page 127)	9V Transformer	
NEW 	D28 DPB AISI316	Stainless steel 316 body. Concealed installation in dry walls as well as concrete, brick walls. Dual power input box. When powered by a 9V transformer features an integrated backup system to be used with a 9V Lithium battery, which enables the product to be used normally in case of a power failure.	9V Battery	352301	
	D28 DPE AISI316		Iron frame available (see page 127)	9V Transformer	
	D28 PROX B	Concealed installation in dry walls. Prox sensor unit	9V Battery	352600	
	D28 PROX E		9V Transformer	352610	

D28 TOUCH SERIES

Electronically operated self closing faucet operated by touch.
 Features a Piezo element integrated in the faucet cap.
 For cold or premixed water.

Advantages:

- Drastically reduces water consumption
- No moving parts, ideal for heavy duty areas
- Non hold open feature
- More possibilities to save water: the water flow can be stopped in the middle of the cycle
- Stable and accurate water flow that can be changed on site
- Easy installation
- Matching IR operated soap dispenser



LEED RATING

WATER SAVING OPTIONS

5 LPM	1.32 GPM	Honeycomb TT
1.89 LPM	0.5 GPM	PCA Spray

PICTURE	PRODUCT NAME	MODEL FEATURES	POWER SUPPLY	CODE NUMBER	DRAWING
	D28 TOUCH DUAL POWER B	<p>Concealed installation in dry walls or brick concrete walls.</p> <p>Powered by an external IP67 Dual power input box, allows the faucet to be used with a 9V battery or a 9V transformer.</p>	9V Battery	352700	
	D28 TOUCH DUAL POWER E	<p>The product could also be powered by a 9V transformer and an integrated backup system to be used with a 9V Lithium battery, which enables the product to be used normally in case of a power failure.</p>	9V Transformer	352710	

MALMO SERIES

Electronic wall mounted faucet operated by IR sensor.
Solenoid valve, sensor and battery are integrated in the spout.

Series includes options for cold or premixed water as well as hot and cold water.

Advantages:

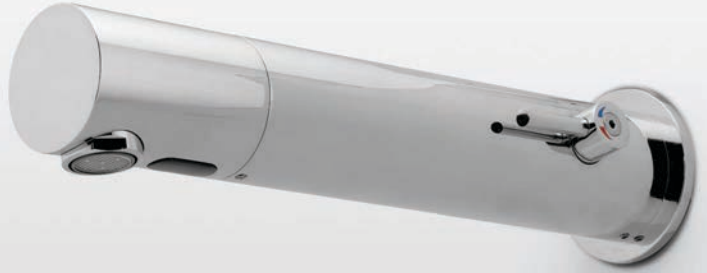

- Drastically reduces water consumption
- No physical contact. Helps to protect users against cross contamination
- Since the sensor, solenoid and battery are inside the body, servicing can be done from the front
- Sensor settings adjustable by remote control
- Easy installation
- Internal solenoid valve
- Matching IR operated soap dispenser



LEED RATING

WATER SAVING OPTIONS

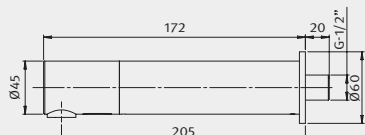
6 LPM	1.58 GPM	SSR PCA Stream
4 LPM	1 GPM	PCA Spray
3 LPM	0.8 GPM	PCA Spray
1.89 LPM	0.5 GPM	PCA Spray
1.3 LPM	0.35 GPM	PCA Spray

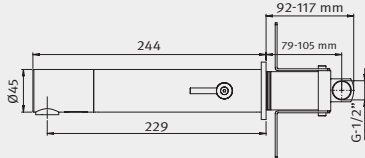
PICTURE	PRODUCT NAME	MODEL FEATURES	POWER SUPPLY	CODE NUMBER	DRAWING
	MALMO	Concealed installation in concrete, brick walls	9V Battery	225865	
	MALMO 1000	Concealed installation in concrete, brick walls. Mixer to adjust water temperature	9V Battery	225860	

TUBULAR SERIES

Electronic wall mounted faucet operated by IR sensor.
Series includes options for cold or premixed water as well as hot and cold water, long spout and various installation options.

Advantages:

- Drastically reduces water consumption
- No physical contact. Helps to protect users against cross contamination
- Suits any washroom due to its minimalist design
- Sensor settings adjustable by remote control
- Easy installation
- Matching IR operated soap dispenser

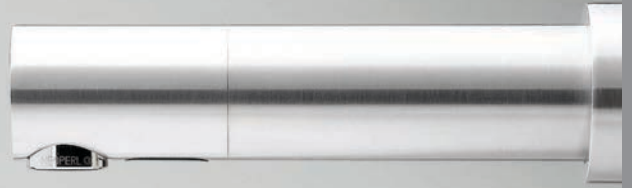







LEED RATING



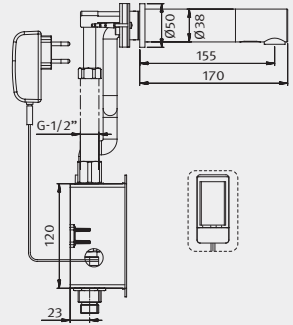

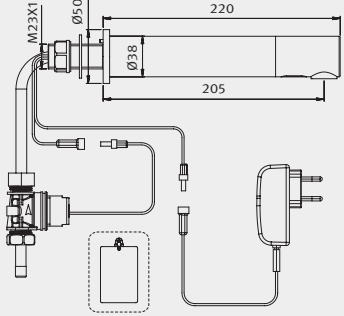

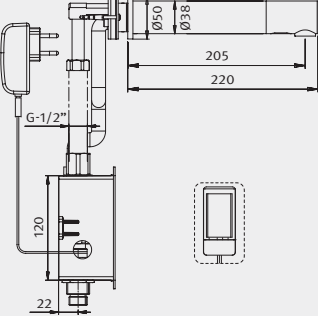

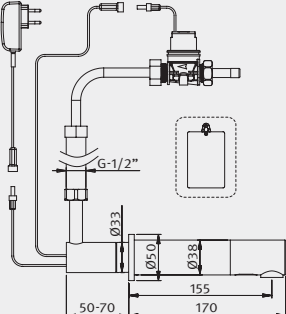

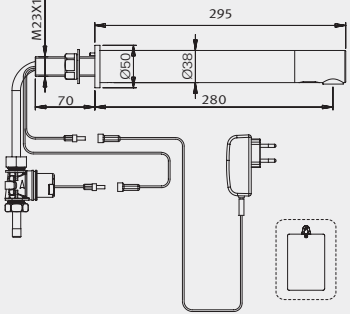
IRON FRAME AVAILABLE

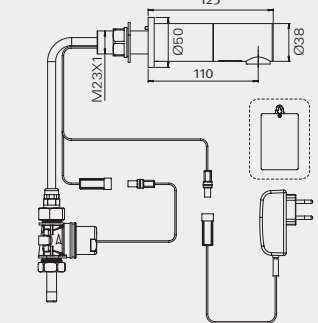
WATER SAVING OPTIONS		
6 LPM	1.58 GPM	SSR PCA Stream
4 LPM	1 GPM	PCA Spray
3 LPM	0.8 GPM	PCA Spray
1.89 LPM	0.5 GPM	PCA Spray
1.3 LPM	0.35 GPM	PCA Spray

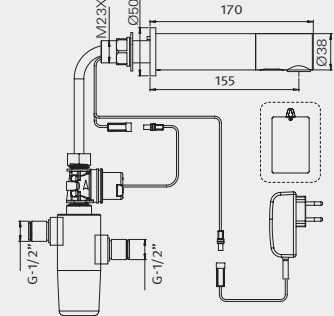
PICTURE	PRODUCT NAME	MODEL FEATURES	POWER SUPPLY	CODE NUMBER	DRAWING
	TUBULAR B	Concealed installation in dry walls	6 x 1.5 AA Batteries	350200	
	TUBULAR E		9V Transformer	350100	
NEW 	TUBULAR B AISI316	Stainless steel 316 body. Concealed installation in dry walls	6 x 1.5 AA Batteries	350208	
	TUBULAR E AISI316		Iron frame available (see page 127)	9V Transformer	

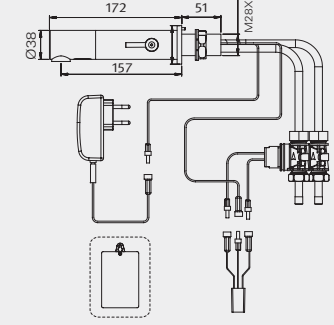
PICTURE	PRODUCT NAME	MODEL FEATURES	POWER SUPPLY	CODE NUMBER	DRAWING
	TUBULAR 2030 B	Concealed installation in concrete or brick walls.	9V Battery	350300	
	TUBULAR 2030 E		9V Transformer	350400	
	TUBULAR LB	Concealed installation in dry walls. Long spout 220 mm	6 x 1.5 AA Batteries	350210	
	TUBULAR LE		9V Transformer	350120	
	TUBULAR 2030 LB	Concealed installation in concrete or brick walls. Long spout 220 mm	9V Battery	350310	
	TUBULAR 2030 LE		9V Transformer	350410	
	TUBULAR CB	Installation from ceiling	6 x 1.5 AA Batteries	350500	
	TUBULAR CE		9V Transformer	350600	

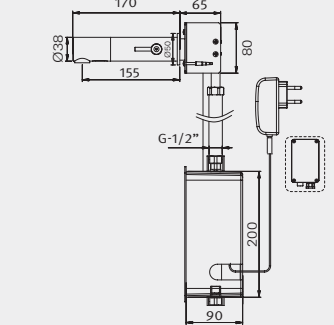
PICTURE	PRODUCT NAME	MODEL FEATURES	POWER SUPPLY	CODE NUMBER	DRAWING
	TUBULAR XLB	Concealed installation in dry walls	6 x 1.5 AA Batteries	350215	
	TUBULAR XLE	Extra long spout 295 mm	9V Transformer	350415	
	TUBULAR PERTH B	Concealed installation in dry walls	6 x 1.5 AA Batteries	350207	
	TUBULAR PERTH E		9V Transformer	350107	
	TUBULAR TB	Concealed installation in dry walls.	6 x 1.5 AA Batteries	350202	
	TUBULAR TE		9V Transformer	350102	
	TUBULAR 1000 B	Concealed installation in dry walls.	6 x 1.5 AA Batteries	350800	
	TUBULAR 1000 E		9V Transformer	350850	
	TUBULAR 1000 B BOX	Installation in concrete or brick walls	9V Battery	350900	
	TUBULAR 1000 E BOX		9V Transformer	350950	

TUBULAR WAVE DP LE

Electronic wall mounted faucet operated by wave on-off IR sensor.
For cold or premixed water.

Options for installation with iron frame.

Advantages:

- Drastically reduces water consumption
- No physical contact. Helps to protect users against cross contamination
- Suits any washroom due to its minimalist design
- Sensor settings adjustable by remote control
- Easy installation
- Matching IR operated soap dispenser



LEED RATING



IRON FRAME AVAILABLE

WATER SAVING OPTIONS

Flow Rate (LPM)	Flow Rate (GPM)	Option
6 LPM	1.58 GPM	SSR PCA Stream
4 LPM	1 GPM	PCA Spray
3 LPM	0.8 GPM	PCA Spray
1.89 LPM	0.5 GPM	PCA Spray
1.3 LPM	0.35 GPM	PCA Spray

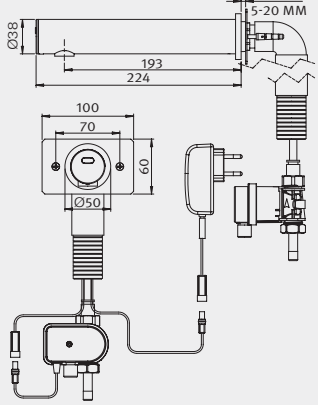
PICTURE	PRODUCT NAME	MODEL FEATURES	POWER SUPPLY	CODE NUMBER	DRAWING
	TUBULAR WAVE DP LE	<p>Concealed installation in dry walls as well as concrete, brick walls.</p> <p>Dual power input box.</p> <p>When powered by a 9V transformer features an integrated backup system to be used with a 9V Lithium battery, which enables the product to be used normally in case of a power failure.</p> <p>Iron frame available (see page 127)</p> <p>Allows activation of the faucet once the users place their hands at a close proximity to the sensor.</p> <p>Water will shut off if the users place their hands at a close proximity to the sensor again or once a factory set flow time of 8 seconds will pass. The flow time is adjustable on site by remote control.</p>	9V Transformer	350190	

TUBULAR TOUCH SERIES

Electronically operated self closing faucet operated by touch.
 Features a Piezo element integrated in the faucet cap.
 For cold or premixed water.
 Includes ring illuminated versions (electricity operated only).

Advantages:







- Drastically reduces water consumption
- No moving parts, ideal for heavy duty areas
- Non hold open feature
- More possibilities to save water: the water flow can be stopped in the middle of the cycle
- Stable and accurate water flow that can be changed on site
- Easy installation

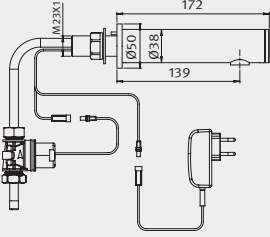

WATER SAVING OPTIONS		
5 LPM	1.32 GPM	Cache Honeycomb TJ
1.89 LPM	0.5 GPM	Cache PCA Spray

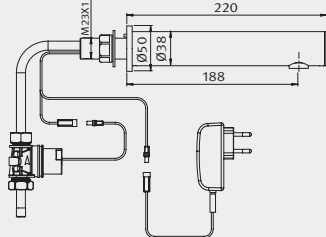

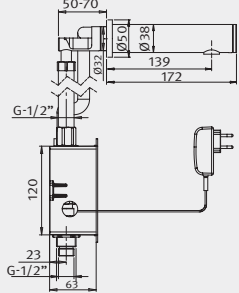
PICTURE	PRODUCT NAME	MODEL FEATURES	POWER SUPPLY	CODE NUMBER	DRAWING
	TUBULAR TOUCH B	Concealed installation in dry walls	6 x 1.5 AA Batteries	350140	
	TUBULAR TOUCH E		9V Transformer	350130	
	TUBULAR TOUCH LB	Concealed installation in dry walls. Long spout 220 mm	6 x 1.5 AA Batteries	350250	
	TUBULAR TOUCH LE		9V Transformer	350150	
	TUBULAR TOUCH 2030 B	Concealed installation in concrete or brick walls	9V Battery	350350	
	TUBULAR TOUCH 2030 E		9V Transformer	350450	
	TUBULAR TOUCH 2030 LB	Concealed installation in concrete or brick walls. Long spout 220 mm	9V Battery	350320	
	TUBULAR TOUCH 2030 LE		9V Transformer	350420	

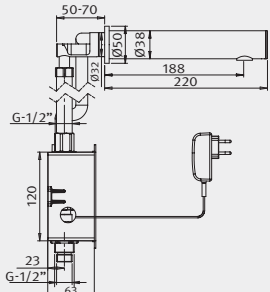
PICTURE	PRODUCT NAME	MODEL FEATURES	POWER SUPPLY	CODE NUMBER	DRAWING
	<p>TUBULAR TOUCH BRE</p>	<p>Concealed installation in dry walls.</p> <p>Features a permanent ring illumination. When a user places his hands within the sensor range, the ring of light blinks while water runs out of the faucet.</p>	<p>9V Transformer</p>	<p>350170</p>	
	<p>TUBULAR TOUCH BR LE</p>	<p>Concealed installation in dry walls.</p> <p>Features a permanent ring illumination. When a user places his hands within the sensor range, the ring of light blinks while water runs out of the faucet.</p> <p>Long spout 220 mm</p>	<p>9V Transformer</p>	<p>350180</p>	
	<p>TUBULAR TOUCH 2030 BRE</p>	<p>Concealed installation in concrete or brick walls.</p> <p>Features a permanent ring illumination. When a user places his hands within the sensor range, the ring of light blinks while water runs out of the faucet.</p>	<p>9V Transformer</p>	<p>350460</p>	
	<p>TUBULAR TOUCH 2030 BR LE</p>	<p>Concealed installation in concrete or brick walls.</p> <p>Features a permanent ring illumination. When a user places his hands within the sensor range, the ring of light blinks while water runs out of the faucet.</p> <p>Long spout 220 mm</p>	<p>9V Transformer</p>	<p>350330</p>	

EXTREME CS SERIES

Electronic wall mounted faucet operated by IR concealed sensor integrated into the spout.

For cold or premixed water.

Advantages:

- Drastically reduces water consumption
- No physical contact. Helps to protect users against cross contamination
- Sensor settings adjustable by remote control
- Easy installation
- Matching IR operated soap dispenser
- Stainless steel AISI 316 spout available upon request







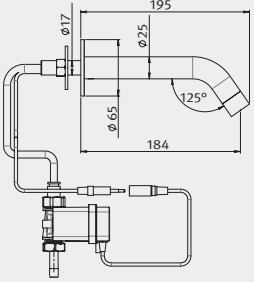

LEED RATING

WATER SAVING OPTIONS

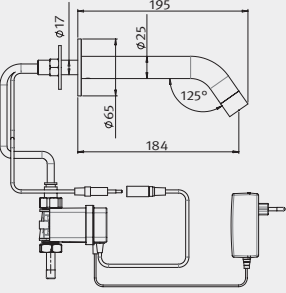
4 LPM	1 GPM	Honeycomb TT
1.89 LPM	0.5 GPM	PCA Spray

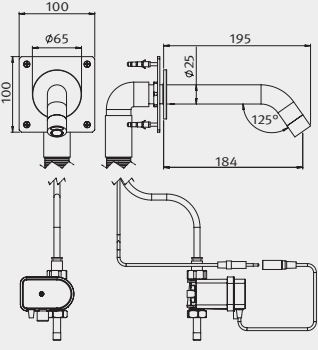

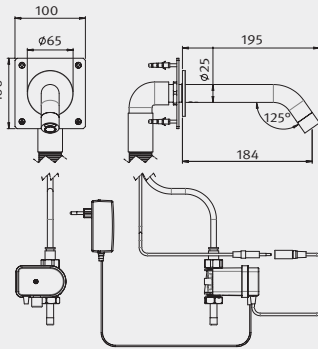
PICTURE	PRODUCT NAME	MODEL FEATURES	POWER SUPPLY	CODE NUMBER	DRAWING
<p>NEW</p> 	EXTREME CS B	<p>Concealed installation in dry walls</p> <p>IP67 Dual power input box that allows the faucet to be used with a 9V battery or a 9V transformer.</p>	9V Battery	237801	
<p>NEW</p> 	EXTREME CS E	<p>EXTREME CS can be also be powered by a 9V transformer and an integrated backup system to be used with a 9V Lithium battery, which enables the product to be used normally in case of a power failure.</p>	9V Transformer	237800	
<p>NEW</p> 	EXTREME CS DPB	<p>Concealed installation in brick walls</p> <p>IP67 Dual power input box that allows the faucet to be used with a 9V battery or a 9V transformer.</p>	9V Battery	237802	
<p>NEW</p> 	EXTREME CS DPE	<p>EXTREME CS can be also be powered by a 9V transformer and an integrated backup system to be used with a 9V Lithium battery, which enables the product to be used normally in case of a power failure.</p>	9V Transformer	237803	

QUADRAT SERIES

Electronic wall mounted faucet operated by IR sensor.

Series includes options for cold or premixed water, long spout models and various installation options.

Advantages:

- Drastically reduces water consumption
- No physical contact. Helps to protect users against cross contamination
- * Unique square design
- Sensor settings adjustable by remote control
- Easy installation
- Matching IR operated soap dispenser



LEED RATING



IRON FRAME AVAILABLE

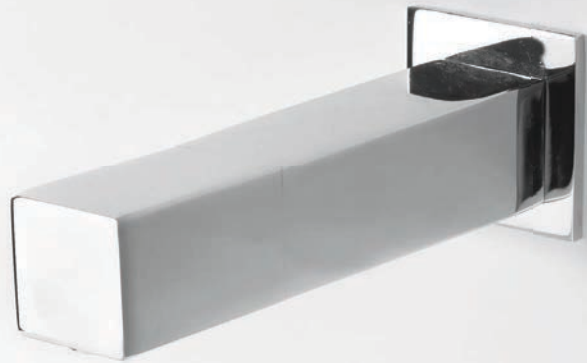

WATER SAVING OPTIONS		
6 LPM	1.58 GPM	SSR PCA Stream
4 LPM	1 GPM	PCA Spray
3 LPM	0.8 GPM	PCA Spray
1.89 LPM	0.5 GPM	PCA Spray
1.3 LPM	0.35 GPM	PCA Spray



PICTURE	PRODUCT NAME	MODEL FEATURES	POWER SUPPLY	CODE NUMBER	DRAWING
	QUADRAT B	Concealed installation in dry walls	6 x 1.5 AA Batteries	351100	
	QUADRAT E		9V Transformer	351200	
	QUADRAT LB	Concealed installation in dry walls. Long spout 220 mm	6 x 1.5 AA Batteries	351105	
	QUADRAT LE		9V Transformer	351205	
	QUADRAT 2030 B	Concealed installation in concrete or brick walls	9V Battery	351300	
	QUADRAT 2030 E		9V Transformer	351400	
	QUADRAT 2030 LB	Concealed installation in concrete or brick walls. Long spout 220 mm	9V Battery	351305	
	QUADRAT 2030 LE		9V Transformer	351405	

NARA Q SERIES

Electronic wall mounted faucet operated by IR sensor.
For cold or premixed water.

Advantages:

- Drastically reduces water consumption
- No physical contact. Helps to protect users against cross contamination
- Concealed installation, all components inside the box which makes it serviceable from the front.
- Sensor settings adjustable by remote control
- Matching flush valves for toilets and urinals
- Easy installation

WATER SAVING OPTIONS		
6 LPM	1.58 GPM	SSR PCA Stream
4 LPM	1 GPM	PCA Spray
3 LPM	0.8 GPM	PCA Spray
1.89 LPM	0.5 GPM	PCA Spray
1.3 LPM	0.35 GPM	PCA Spray



PICTURE	PRODUCT NAME	MODEL FEATURES	POWER SUPPLY	CODE NUMBER	DRAWING
	NARA Q	Concealed installation in concrete, brick walls	9V Battery	360510	
	NARA QE		9V Transformer	360500	

CUBICA SERIES

Electronic wall mounted faucet operated by IR sensor.
For cold or premixed water.

Advantages:

- Drastically reduces water consumption
- No physical contact. Helps to protect users against cross contamination
- Luxury rectangular design
- Sensor settings adjustable by remote control
- Easy installation

WATER SAVING OPTIONS		
5 LPM	1.32 GPM	Honeycomb TT Laminar
1.89 LPM	0.5 GPM	PCA Spray



PICTURE	PRODUCT NAME	MODEL FEATURES	POWER SUPPLY	CODE NUMBER	DRAWING
	CUBICA B	Concealed installation in dry walls	6 x 1.5 AA Batteries	360100	
	CUBICA E		9V Transformer	360200	
	CUBICA 2030 B	Concealed installation in concrete, brick walls	9V Battery	360300	
	CUBICA 2030 E		9V Transformer	360400	

APOLLO AL SERIES

Electronic wall mounted faucet operated by IR sensor.

For cold or premixed water.

Includes options for wave or prox operation, and accessories for brick wall installation.

Advantages:

- Drastically reduces water consumption
- No physical contact. Helps to protect users against cross contamination
- Concealed installation, all components inside the box which makes it serviceable from the front
- Sensor settings adjustable by remote control
- Easy installation



LEED RATING



STERN MEDICAL



WAVE & PROX OPTIONS



WATER SAVING OPTIONS

6 LPM	1.58 GPM	SSR PCA Stream
4 LPM	1 GPM	PCA Spray
3 LPM	0.8 GPM	PCA Spray
1.89 LPM	0.5 GPM	PCA Spray
1.3 LPM	0.35 GPM	PCA Spray

PICTURE	PRODUCT NAME	MODEL FEATURES	POWER SUPPLY	CODE NUMBER	DRAWING
	APOLLO ALB	<p>Concealed installation in dry walls.</p> <p>Default Wave activation: Once the users place their hands at a close proximity to the sensor.</p> <p>Water will shut off if the users place their hands at a close proximity to the sensor again or once a factory set flow time of 8 seconds will pass. The flow time is adjustable on site by remote control.</p>	9V battery	340600	
	APOLLO ALE	<p>Optional Prox activation: Automatic activation when the users bring their hands within the sensor range, and stops when the users remove their hands.</p>	9V Transformer	340700	

EXTENSION KIT APOLLO AL	For brick wall installations	07240060	
EXTENSION KIT FOR WAVE / PROX SENSOR (REQUIRES A SPECIAL MATCHING SENSOR)		07240061	

MEDICAL SERIES

Electronic wall mounted faucet operated by IR sensor.

Features an integrated thermostatic mixer to prevent scalding operation and temperature control.

Advantages:

- Drastically reduces water consumption
- No physical contact. Helps to protect users against cross contamination
- Thermostatic control for optimum temperature
- Ideal for healthcare institutions
- Chrome plated brass body with metallic thermostatic handle
- Ideal for retrofit installations
- Sensor settings adjustable by remote control
- Internal solenoid valve
- Easy installation



WATER SAVING OPTIONS		
6 LPM	1.58 GPM	SSR PCA Stream
4 LPM	1 GPM	PCA Spray
3 LPM	0.8 GPM	PCA Spray
1.89 LPM	0.5 GPM	PCA Spray
1.3 LPM	0.35 GPM	PCA Spray



LEED RATING



STERN MEDICAL



PREVENT SCALDING



PICTURE	PRODUCT NAME	MODEL FEATURES	POWER SUPPLY	CODE NUMBER	DRAWING
	APOLLO MEDICAL FB	Exposed installation Gooseneck spout	9V Battery	314530	
	APOLLO MEDICAL FE		9V Transformer	314540	
	APOLLO MEDICAL B	Exposed installation Swivel spout	9V Battery	314500	
	APOLLO MEDICAL E		9V Transformer	314510	
	MEDICAL 1000 TE	Exposed installation Body integrated spout	9V Transformer	314600	

9V BATTERY

COVER

BATTERY COVER

INTEROPERABLE SOLENOID VALVE

ESCUTCHEON

ECCENTRIC

THERMOSTATIC CARTRIDGE INTEGRATED WITH A HOT LIMIT STOPPER

METAL THERMOSTATIC MIXING HANDLE

FULL BRASS FAUCET BODY

REMOTE CONTROL

IR SENSOR:

- a. Body recognition program
- b. Sensor functions adjustable by remote control
- c. Various hygiene flush options available



APOLLO FREE SERIES

Electronic wall mounted faucet operated by IR sensor.
Powered by an internal 9V battery. For cold or premixed water.

Advantages:

- Drastically reduces water consumption
- No physical contact. Helps to protect users against cross contamination
- Since the sensor, solenoid and battery are inside the body, servicing is extremely easy
- Ideal for retrofit projects
- Sensor settings adjustable by remote control
- Easy installation



WATER SAVING OPTIONS		
6 LPM	1.58 GPM	SSR PCA Stream
4 LPM	1 GPM	PCA Spray
3 LPM	0.8 GPM	PCA Spray
1.89 LPM	0.5 GPM	PCA Spray
1.3 LPM	0.35 GPM	PCA Spray



LEED RATING

PICTURE	PRODUCT NAME	MODEL FEATURES	POWER SUPPLY	CODE NUMBER	DRAWING
	APOLLO FREE	Exposed installation	9V Battery	340100	

WASHFREE 1000

Electronic wall mounted faucet operated by wave IR sensor.
For cold or premixed water. Includes option for a longer bracket.

Advantages:

- Drastically reduces water consumption
- No physical contact. Helps to protect users against cross contamination
- Swivel spout
- Ideal for utility sinks
- Since the sensor, the solenoid and the battery are inside the body, servicing is extremely easy
- Ideal for retrofit installations
- Sensor settings adjustable by remote control
- Easy installation



LEED RATING



WAVE & PROX OPTIONS



WATER SAVING OPTIONS		
6 LPM	1.58 GPM	SSR PCA Stream
4 LPM	1 GPM	PCA Spray
3 LPM	0.8 GPM	PCA Spray
1.89 LPM	0.5 GPM	PCA Spray
1.3 LPM	0.35 GPM	PCA Spray

PICTURE	PRODUCT NAME	MODEL FEATURES	POWER SUPPLY	CODE NUMBER	DRAWING
	WASHFREE 1000	Exposed installation Allows activation of the faucet once the users place their hands at a close proximity to the sensor. Water will shut off if the users place their hands at a close proximity to the sensor again or once a factory set flow time of 8 seconds will pass. The flow time is adjustable on site by remote control.	9V Battery	316010	
	LONG BRACKET 200 MM			0705175	

PROX, WAVE & TOUCH SOLUTIONS

Touch free & Touch operated faucet kits operated by an IR sensor or a Piezo button.
To be integrated in a faucet application to deliver water with or without touch. For cold or premixed water.

Advantages:

Touch Free operation:

- Drastically reduces water consumption
- No physical contact. Helps to protect users against cross contamination
- Sensor settings adjustable by remote control

Touch Operation:





- Drastically reduces water consumption
- Non hold open feature
- More possibilities to save water: the water flow can be stopped in the middle of the cycle
- Stable and accurate water flow that can be changed on site



LEED RATING

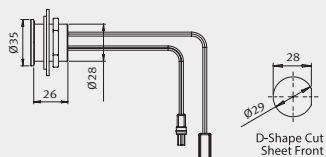

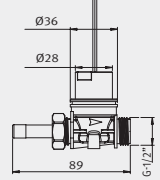
WAVE & PROX OPTIONS

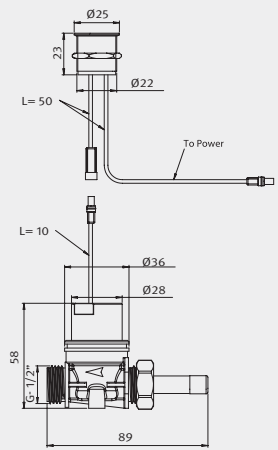
PICTURE	PRODUCT NAME	MODEL FEATURES	POWER SUPPLY	CODE NUMBER	DRAWING
	PROX KIT FOR FAUCET	Touch free prox operation. Allows automatic activation when the users bring their hands within the sensor range, and stops when the users remove their hands.	9V Battery / 9V Transformer	620200	
	WAVE KIT FOR FAUCET	Touch free wave operation. Allows activation of the faucet/unit once the users place their hands at a close proximity to the sensor. Water will shut off if the users place their hands at a close proximity to the sensor again or once a factory set flow time of 8 seconds will pass. The flow time is adjustable on site by remote control.	9V Battery / 9V Transformer	620400	
	APS KIT FOR FAUCET	Touch operation Allows activation of the faucet/unit once the users touch the designated area of the Piezo button. Water will shut off if the users touch the designated area again or once a factory set flow time of 8 seconds will pass.	9V Battery / 9V Transformer (not included)	07225008	

SOAP DISPENSERS

57-82



CLASSIC 59-60



TRENDY 61-62



EXTREME 63-64



ELITE 65-68



GREEN 69-70



GREEN 28 71-72



QUADRAT 73-74



TUBULAR 75-78



EXTREME CS 79



MULTIFEED KITS 80-82

CLASSIC SOAP DISPENSER

Deck-mounted touch-free electronic soap dispenser for non-proprietary soap

Features:

- 100% heavy-duty one piece brass body
- IR sensor in dispenser spout
- Concealed sensor integrated into the spout
- Peristaltic pump

Options:

- 0.26 US gallon (1L) soap bottle
- 1.6 US gallon (6L) soap tank
- Multiple soap dispensers installation (up to six (6) dispensers) with a single 1.6 US gallon (1L) tank
- Matching IR operated faucet
- Remote control

Advantages:

- Drastically reduces soap consumption
- Cross contamination protection - no physical contact
- Clog and backflow prevention - with designated peristaltic pump
- Accurate soap dosage - adjustable by remote control
- Maximized savings - can be used with any non-proprietary soap
- Easy to install and refill
- Highly durable - for heavy traffic locations

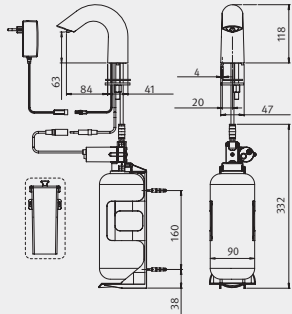
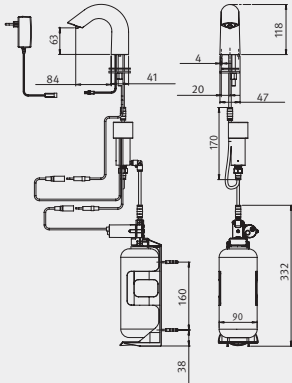

STANDARD SOAP DISPENSER VERSIONS

PICTURE	PRODUCT NAME	MODEL FEATURES	POWER SUPPLY	CODE NUMBER	DRAWING
	CLASSIC SOAP DISPENSER B	Delivers liquid soap	Battery box for six (6) DD batteries	292400	
	CLASSIC SOAP DISPENSER E		12V Transformer	292410	
	CLASSIC FOAM E	Delivers foam soap	12V Transformer	292300	

6-PACK SOAP DISPENSER

PRODUCT NAME	MODEL FEATURES	POWER SUPPLY	CODE NUMBER	DRAWING
CLASSIC SD 6-PACK B	Includes: Six (6) soap/foam dispenser units and one (1) remote control	Battery box for six (6) DD batteries	292401	
CLASSIC SD 6-PACK E		12V Transformer	292411	
CLASSIC FOAM 6-PACK E		12V Transformer	292301	

1.6 GALLON (6L) SOAP DISPENSER VERSIONS

PRODUCT NAME	MODEL FEATURES	POWER SUPPLY	CODE NUMBER	DRAWING
MF CLASSIC SOAP DISPENSER	Delivers liquid soap Deck mounted touch free electronic soap dispenser to be used with Stern's Multifeed kits for multiple soap dispensers installation	12V Transformer	07292177	
MF CLASSIC FOAM DISPENSER	Delivers foam soap Deck mounted touch free electronic foam dispenser to be used with Stern's Multifeed kits for multiple soap dispensers installation	12V Transformer	07292207	
CLASSIC SD 1.6 E	Delivers liquid soap 1.6 gallon (6L) tank kit for an individual soap dispenser	12V Transformer	292416	



TRENDY SOAP DISPENSER

Deck-mounted touch-free electronic soap dispenser for non-proprietary soap

Features:

- 100% heavy-duty one piece brass body
- IR sensor in dispenser spout
- Peristaltic pump

Options:



- Tall version for counter top sink
- Anti-rotation pin
- 0.26 US gallon (1L) soap bottle
- 1.6 US gallon (6L) soap tank
- Multiple soap dispensers installation (up to six (6) dispensers) with a single 1.6 US gallon (1L) tank
- Matching IR operated faucet
- Remote control

Advantages:

- Drastically reduces soap consumption
- Cross contamination protection - no physical contact
- Clog and backflow prevention - with designated peristaltic pump
- Accurate soap dosage - adjustable by remote control
- Maximized savings - can be used with any non-proprietary soap
- Easy to install and refill
- Highly durable - for heavy traffic locations

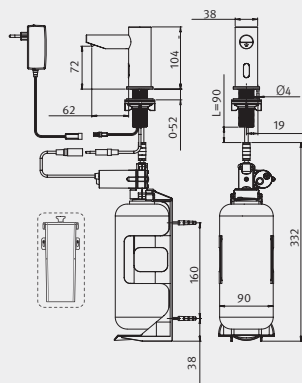

STANDARD SOAP DISPENSER VERSIONS

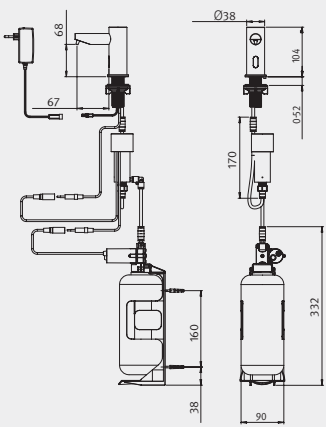
PICTURE	PRODUCT NAME	MODEL FEATURES	POWER SUPPLY	CODE NUMBER	DRAWING
	TRENDY SOAP DISPENSER B	Delivers liquid soap	Battery box for six (6) DD batteries	239910	
	TRENDY SOAP DISPENSER E		12V Transformer	239900	
	TRENDY FOAM E	Delivers foam soap	12V Transformer	239930	

STANDARD SOAP DISPENSER VERSIONS

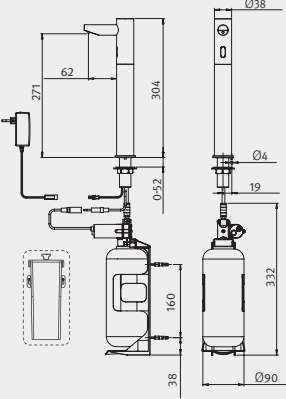
PICTURE	PRODUCT NAME	MODEL FEATURES	POWER SUPPLY	CODE NUMBER	DRAWING
	TRENDY SOAP DISPENSER PLUS B	Delivers liquid soap	Battery box for six (6) DD batteries	239912	
	TRENDY SOAP DISPENSER PLUS E	Tall version: 12" (304 mm) body	12V Transformer	239902	

6-PACK LIQUID SOAP DISPENSER

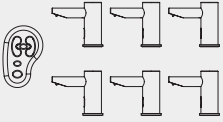
PRODUCT NAME	MODEL FEATURES	POWER SUPPLY	CODE NUMBER	DRAWING
TRENDY SD 6-PACK B	Includes: Six (6) soap dispenser units and one (1) remote control	Battery box for six (6) DD batteries	239911	
TRENDY SD 6-PACK E		12V Transformer	239901	

1.6 GALLON (6L) SOAP DISPENSER VERSIONS

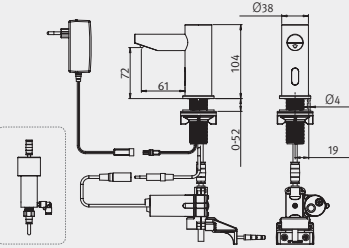
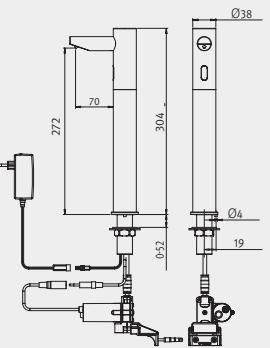
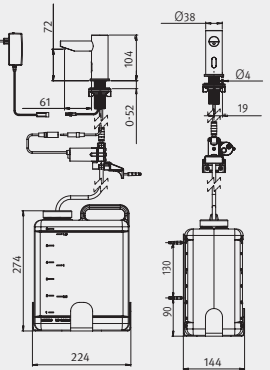
PRODUCT NAME	MODEL FEATURES	POWER SUPPLY	CODE NUMBER	DRAWING
MF TRENDY SOAP DISPENSER	Delivers liquid soap Deck mounted touch free electronic soap dispenser to be used with Stern's Multifeed kits for multiple soap dispensers installation	12V Transformer	07292073	
MF TRENDY FOAM DISPENSER	Delivers foam soap Deck mounted touch free electronic foam dispenser to be used with Stern's Multifeed kits for multiple soap dispensers installation	12V Transformer	07292183	
MF TRENDY SD PLUS	Delivers liquid soap Deck mounted touch free electronic soap dispenser to be used with Stern's Multifeed kits for multiple soap dispensers installation	12V Transformer	07292099	
TRENDY SD 1.6 E	Delivers liquid soap 1.6 gallon (6L) tank kit for an individual soap dispenser	12V Transformer	239916	

EXTREME SOAP DISPENSER

Deck-mounted touch-free electronic soap dispenser for non-proprietary soap

Features:

- 100% heavy-duty one piece brass body
- IR sensor in dispenser spout
- Peristaltic pump

Options:

- Tall version for counter top sink
- Anti-rotation pin
- 0.26 US gallon (1L) soap bottle
- 1.6 US gallon (6L) soap tank
- Multiple soap dispensers installation (up to six (6) dispensers) with a single 1.6 US gallon (1L) tank
- Matching IR operated faucet
- Remote control

Advantages:

- Drastically reduces soap consumption
- Cross contamination protection - no physical contact
- Clog and backflow prevention - with designated peristaltic pump
- Accurate soap dosage - adjustable by remote control
- Maximized savings - can be used with any non-proprietary soap
- Easy to install and refill
- Highly durable - for heavy traffic locations



STANDARD SOAP DISPENSER VERSIONS

PICTURE	PRODUCT NAME	MODEL FEATURES	POWER SUPPLY	CODE NUMBER	DRAWING
	EXTREME SOAP DISPENSER B	Delivers liquid soap	Battery box for six (6) DD batteries	237920	
	EXTREME SOAP DISPENSER E		12V Transformer	237900	
	EXTREME SOAP DISPENSER PLUS B	Delivers liquid soap	Battery box for six (6) DD batteries	237922	
	EXTREME SOAP DISPENSER PLUS E		Tall version: 12" (304 mm) body 12V Transformer	237905	

6-PACK LIQUID SOAP DISPENSER VERSIONS

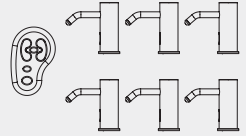
PRODUCT NAME	MODEL FEATURES	POWER SUPPLY	CODE NUMBER	DRAWING
EXTREME SD 6-PACK B	Includes: Six (6) soap dispenser units and one (1) remote control	Battery box for six (6) DD batteries	237921	
EXTREME SD 6-PACK E		12V Transformer	237901	

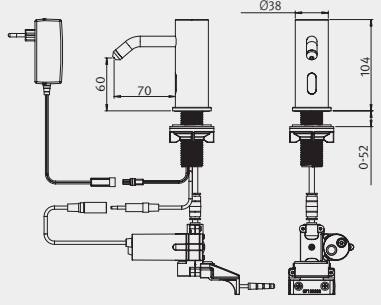
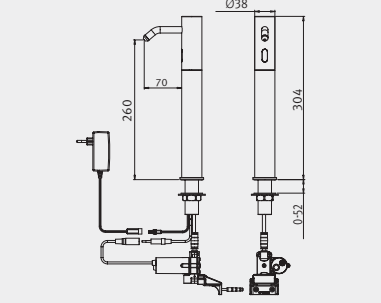
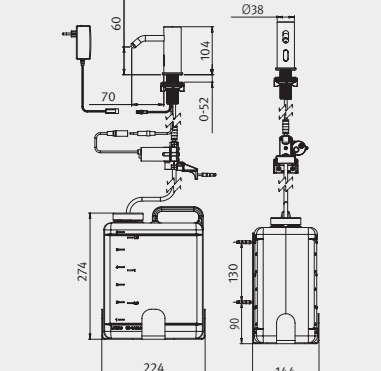

1.6 GALLON (6L) SOAP DISPENSER VERSIONS

PRODUCT NAME	MODEL FEATURES	POWER SUPPLY	CODE NUMBER	DRAWING
MF EXTREME SOAP DISPENSER	Delivers liquid soap Deck mounted touch free electronic soap dispenser to be used with Stern's Multifeed kits for multiple soap dispensers installation	12V Transformer	07292056	
MF EXTREME SD PLUS	Delivers liquid soap Deck mounted touch free electronic soap dispenser to be used with Stern's Multifeed kits for multiple soap dispensers installation	12V Transformer	07292095	
EXTREME SD 1.6 E	Delivers liquid soap 1.6 gallon (6L) tank kit for an individual soap dispenser	12V Transformer	237916	

ELITE SOAP DISPENSER

Deck-mounted touch-free electronic soap dispenser for non-proprietary soap

Features:

- 100% heavy-duty one piece brass body
- IR sensor in dispenser spout
- Peristaltic pump

Options:



- Tall version for counter top sink
- Anti-rotation pin
- 0.26 US gallon (1L) soap bottle
- 1.6 US gallon (6L) soap tank
- Multiple soap dispensers installation (up to six (6) dispensers) with a single 1.6 US gallon (1L) tank
- Matching IR operated faucet
- Remote control

Advantages:

- Drastically reduces soap consumption
- Cross contamination protection - no physical contact
- Clog and backflow prevention - with designated peristaltic pump
- Accurate soap dosage - adjustable by remote control
- Maximized savings - can be used with any non-proprietary soap
- Easy to install and refill
- Highly durable - for heavy traffic locations

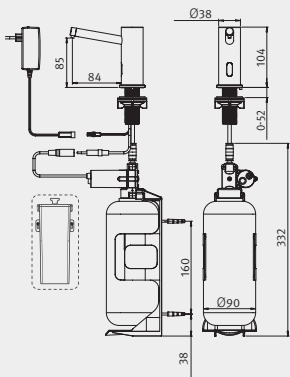

STANDARD SOAP DISPENSER VERSIONS

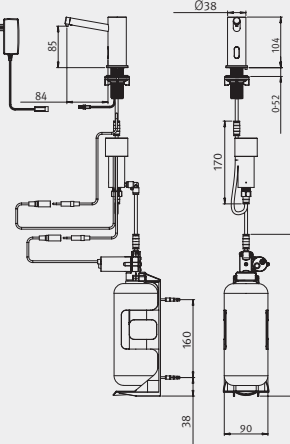
PICTURE	PRODUCT NAME	MODEL FEATURES	POWER SUPPLY	CODE NUMBER	DRAWING
	ELITE SOAP DISPENSER B	Delivers liquid soap	Battery box for six (6) DD batteries	236110	
	ELITE SOAP DISPENSER E		12V Transformer	236100	
	ELITE FOAM E	Delivers foam soap	12V Transformer	236120	

STANDARD SOAP DISPENSER VERSIONS

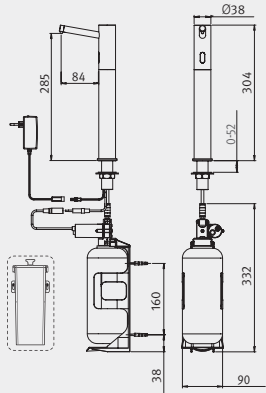
PICTURE	PRODUCT NAME	MODEL FEATURES	POWER SUPPLY	CODE NUMBER	DRAWING
	ELITE SOAP DISPENSER PLUS B	Delivers liquid soap	Battery box for six (6) DD batteries	236107	
	ELITE SOAP DISPENSER PLUS E	Tall version: 12" (304 mm) body	12V Transformer	236105	

6-PACK SOAP DISPENSER

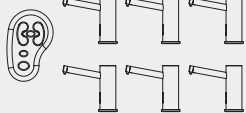
PRODUCT NAME	MODEL FEATURES	POWER SUPPLY	CODE NUMBER	DRAWING
ELITE SD 6-PACK B	Includes: Six (6) soap/foam dispenser units and one (1) remote control	Battery box for six (6) DD batteries	236111	
ELITE SD 6-PACK E		12V Transformer	236101	
ELITE FOAM 6-PACK E		12V Transformer	236121	

1.6 GALLON (6L) SOAP DISPENSER VERSIONS

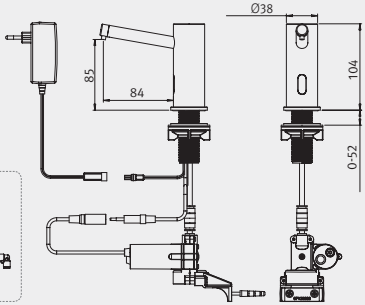
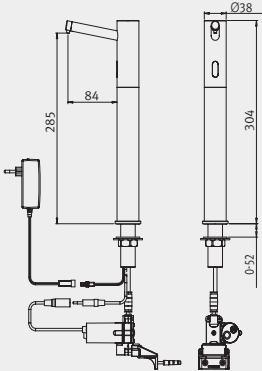
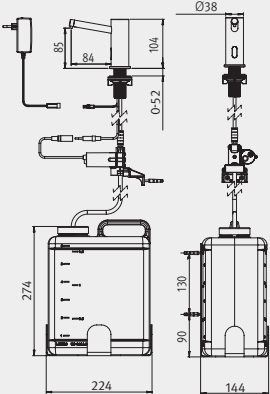
PRODUCT NAME	MODEL FEATURES	POWER SUPPLY	CODE NUMBER	DRAWING
MF ELITE SOAP DISPENSER	Delivers liquid soap Deck mounted touch free electronic soap dispenser to be used with Stern's Multifeed kits for multiple soap dispensers installation	12V Transformer	07292077	
MF ELITE FOAM DISPENSER	Delivers foam soap Deck mounted touch free electronic foam dispenser to be used with Stern's Multifeed kits for multiple soap dispensers installation	12V Transformer	07292205	
MF ELITE SD PLUS	Delivers liquid soap Deck mounted touch free electronic soap dispenser to be used with Stern's Multifeed kits for multiple soap dispensers installation	12V Transformer	07292093	
ELITE SD 1.6 E	Delivers liquid soap 1.6 gallon (6L) tank kit for an individual soap dispenser	12V Transformer	236216	

ELITE SOAP DISPENSER AISI316

Deck-mounted touch-free electronic soap dispenser for non-proprietary soap

Features:

- 100% heavy-duty one piece brass body
- IR sensor in dispenser spout
- Peristaltic pump

Options:

- Tall version for counter top sink
- 0.26 US gallon (1L) soap bottle
- 1.6 US gallon (6L) soap tank
- Multiple soap dispensers installation (up to six (6) dispensers) with a single 1.6 US gallon (6L) tank
- Matching IR operated faucet
- Alternative 4.4" (112mm) long spout
- Remote control

Advantages:

- Drastically reduces soap consumption
- Cross contamination protection - no physical contact
- Clog and backflow prevention - with designated peristaltic pump
- Accurate soap dosage - adjustable by remote control
- Maximized savings - can be used with any non-proprietary soap
- Easy to install and refill
- Highly durable - for heavy traffic locations



STANDARD SOAP DISPENSER VERSIONS

PICTURE	PRODUCT NAME	MODEL FEATURES	POWER SUPPLY	CODE NUMBER	DRAWING
	ELITE SOAP DISPENSER B AISI316	Delivers liquid soap	Battery box for six (6) DD batteries	236113	
	ELITE SOAP DISPENSER E AISI316	Stainless Steel AISI 316 body	12V Transformer	236103	
	ELITE FOAM E AISI316	Delivers foam soap Stainless Steel AISI 316 body	12V Transformer	236122	

STANDARD SOAP DISPENSER VERSIONS

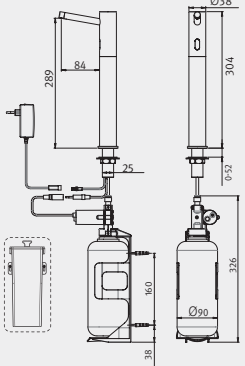
PICTURE	PRODUCT NAME	MODEL FEATURES	POWER SUPPLY	CODE NUMBER	DRAWING
	ELITE SOAP DISPENSER PLUS B AISI316	Delivers liquid soap	Battery box for six (6) DD batteries	236109	
	ELITE SOAP DISPENSER PLUS E AISI316	Tall version: 12" (304 mm) body Stainless Steel AISI 316 body	12V Transformer	236104	

6-PACK SOAP DISPENSER

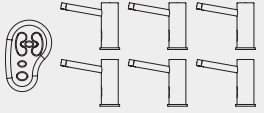
PRODUCT NAME	MODEL FEATURES	POWER SUPPLY	CODE NUMBER	DRAWING
ELITE SD 6-PACK B AISI316	Includes: Six (6) soap/foam dispenser units and one (1) remote control	Battery box for six (6) DD batteries	236114	
ELITE SD 6-PACK E AISI316		12V Transformer	236117	
ELITE FOAM 6-PACK E AISI316		12V Transformer	236123	

1.6 GALLON (6L) SOAP DISPENSER VERSIONS

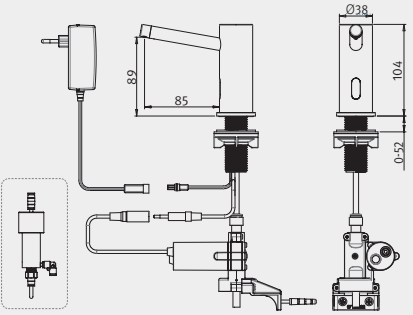
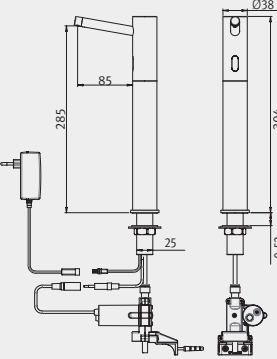
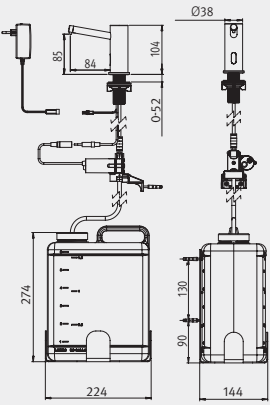
PRODUCT NAME	MODEL FEATURES	POWER SUPPLY	CODE NUMBER	DRAWING
MF ELITE SOAP DISPENSER AISI316	Delivers liquid soap Deck mounted touch free electronic soap dispenser to be used with Stern's Multifeed kits for multiple soap dispensers installation Stainless Steel AISI 316 body	12V Transformer	07292239	
MF ELITE FOAM DISPENSER AISI316	Delivers foam soap Deck mounted touch free electronic foam dispenser to be used with Stern's Multifeed kits for multiple soap dispensers installation Stainless Steel AISI 316 body	12V Transformer	07292240	
MF ELITE SD PLUS AISI316	Delivers liquid soap Deck mounted touch free electronic soap dispenser to be used with Stern's Multifeed kits for multiple soap dispensers installation Stainless Steel AISI 316 body	12V Transformer	07292241	
ELITE SD 1.6 E AISI316	Delivers liquid soap 1.6 gallon (6L) tank kit for an individual soap dispenser Stainless Steel AISI 316 body	12V Transformer	236126	

GREEN SOAP DISPENSER

Deck-mounted touch-free electronic soap dispenser for non-proprietary soap

Features:

- 100% heavy-duty one piece brass body
- IR sensor in dispenser spout
- Peristaltic pump

Options:



- 0.26 US gallon (1L) soap bottle
- 1.6 US gallon (6L) soap tank
- Multiple soap dispensers installation (up to six (6) dispensers) with a single 1.6 US gallon (6L) tank
- Matching IR operated faucet
- Remote control

Advantages:

- Drastically reduces soap consumption
- Cross contamination protection - no physical contact
- Clog and backflow prevention - with designated peristaltic pump
- Accurate soap dosage - adjustable by remote control
- Maximized savings - can be used with any non-proprietary soap
- Easy to install and refill
- Highly durable - for heavy traffic locations

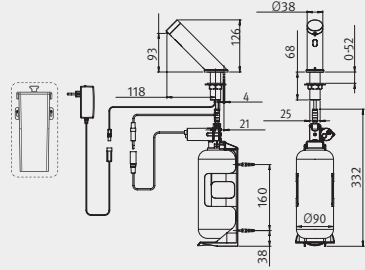

STANDARD SOAP DISPENSER VERSIONS

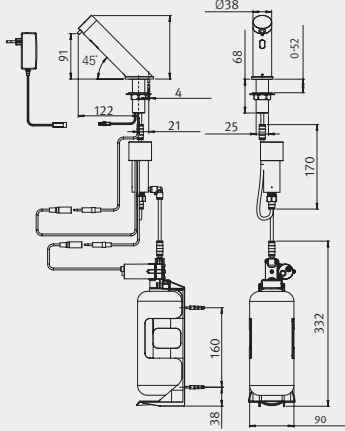
PICTURE	PRODUCT NAME	MODEL FEATURES	POWER SUPPLY	CODE NUMBER	DRAWING
	GREEN SOAP DISPENSER B	Delivers liquid soap	Battery box for six (6) DD batteries	225845	
	GREEN SOAP DISPENSER E	Includes a brass base for abuse protection in high traffic locations	12V Transformer	225840	
	GREEN FOAM E	Delivers foam soap Includes a brass base for abuse protection in high traffic locations	12V Transformer	225842	

6-PACK SOAP DISPENSER

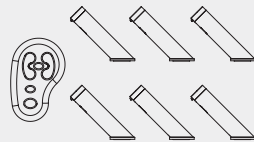
PRODUCT NAME	MODEL FEATURES	POWER SUPPLY	CODE NUMBER	DRAWING
GREEN SD 6-PACK B	Includes: Six (6) soap/foam dispenser units and one (1) remote control	Battery box for six (6) DD batteries	225846	
GREEN SD 6-PACK E		12V Transformer	225841	
GREEN FOAM 6-PACK E		12V Transformer	225843	

1.6 GALLON (6L) SOAP DISPENSER VERSIONS

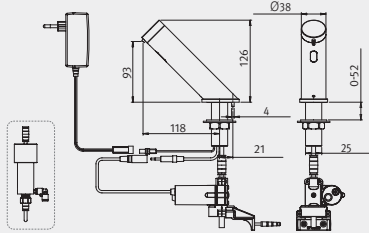
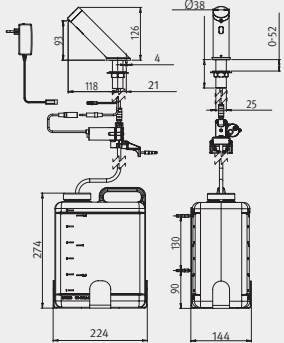
PRODUCT NAME	MODEL FEATURES	POWER SUPPLY	CODE NUMBER	DRAWING
MF GREEN SOAP DISPENSER	Delivers liquid soap Deck mounted touch free electronic soap dispenser to be used with Stern's Multifeed kits for multiple soap dispensers installation	12V Transformer	07292062	
MF GREEN FOAM DISPENSER	Delivers foam soap Deck mounted touch free electronic foam dispenser to be used with Stern's Multifeed kits for multiple soap dispensers installation	12V Transformer	07292228	
GREEN SD 1.6 E	Delivers liquid soap 1.6 gallon (6L) tank kit for an individual soap dispenser	12V Transformer	225816	

GREEN 28 SOAP DISPENSER

Deck-mounted touch-free electronic soap dispenser for non-proprietary soap

Features:

- 100% heavy-duty one piece brass body
- IR sensor in dispenser spout
- Peristaltic pump

Options:



- 0.26 US gallon (1L) soap bottle
- 1.6 US gallon (6L) soap tank
- Multiple soap dispensers installation (up to six (6) dispensers) with a single 1.6 US gallon (6L) tank
- Matching IR operated faucet
- Remote control

Advantages:

- Drastically reduces soap consumption
- Cross contamination protection - no physical contact
- Clog and backflow prevention - with designated peristaltic pump
- Accurate soap dosage - adjustable by remote control
- Maximized savings - can be used with any non-proprietary soap
- Easy to install and refill
- Highly durable - for heavy traffic locations

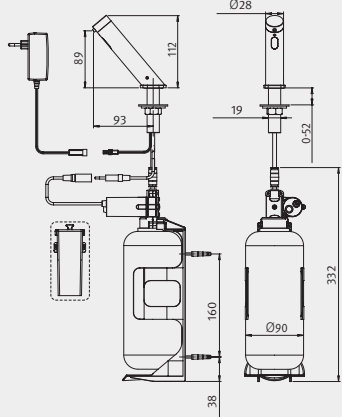

SOAP DISPENSER VERSIONS

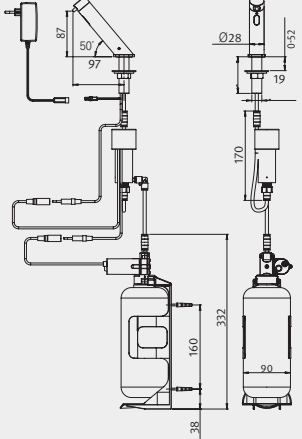
PICTURE	PRODUCT NAME	MODEL FEATURES	POWER SUPPLY	CODE NUMBER	DRAWING
	GREEN 28 SOAP DISPENSER B	Delivers liquid soap Includes a brass base for abuse protection in high traffic locations	Battery box for six (6) DD batteries	352900	
	GREEN 28 SOAP DISPENSER E		12V Transformer	352910	
	GREEN 28 FOAM E	Delivers foam soap Includes a brass base for abuse protection in high traffic locations	12V Transformer	352920	

6-PACK LIQUID SOAP DISPENSER

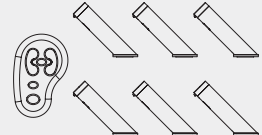
PRODUCT NAME	MODEL FEATURES	POWER SUPPLY	CODE NUMBER	DRAWING
GREEN 28 SD 6-PACK B	Includes: Six (6) soap dispenser units and one (1) remote control	Battery box for six (6) DD batteries	352901	
GREEN 28 SD 6-PACK E		12V Transformer	352911	

1.6 GALLON (6L) SOAP DISPENSER VERSIONS

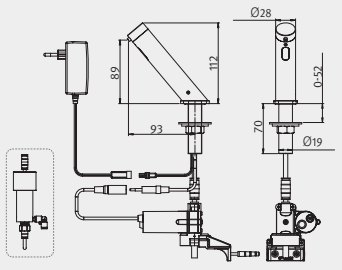
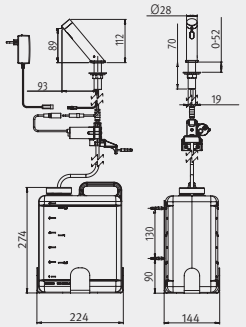
PRODUCT NAME	MODEL FEATURES	POWER SUPPLY	CODE NUMBER	DRAWING
MF GREEN 28 SOAP DISPENSER	Delivers liquid soap Deck mounted touch free electronic soap dispenser to be used with Stern's Multifeed kits for multiple soap dispensers installation	12V Transformer	07292155	
MF GREEN 28 FOAM DISPENSER	Delivers foam soap Deck mounted touch free electronic foam dispenser to be used with Stern's Multifeed kits for multiple soap dispensers installation	12V Transformer	07292206	
GREEN 28 SD 1.6 E	Delivers liquid soap 1.6 gallon (6L) tank kit for an individual soap dispenser	12V Transformer	352916	

QUADRAT SOAP DISPENSER

Wall-mounted touch-free electronic soap dispenser for non-proprietary soap

Features:

- 100% heavy-duty one piece brass body
- IR sensor in dispenser spout
- Peristaltic pump

Options:

- 0.26 US gallon (1L) soap bottle
- 1.6 US gallon (6L) soap tank
- Multiple soap dispensers installation (up to six (6) dispensers) with a single 1.6 US gallon (6L) tank
- Matching IR operated faucet
- Remote control

Advantages:

- Drastically reduces soap consumption
- Cross contamination protection - no physical contact
- Clog and backflow prevention - with designated peristaltic pump
- Accurate soap dosage - adjustable by remote control
- Maximized savings - can be used with any non-proprietary soap
- Easy to install and refill
- Highly durable - for heavy traffic locations



STANDARD SOAP DISPENSER VERSIONS

PICTURE	PRODUCT NAME	MODEL FEATURES	POWER SUPPLY	CODE NUMBER	DRAWING
	QUADRAT SOAP DISPENSER B	Delivers liquid soap	Battery box for six (6) DD batteries	351910	
	QUADRAT SOAP DISPENSER E		12V Transformer	351900	
	QUADRAT SOAP DISPENSER 2030 B	Delivers liquid soap	Battery box for six (6) DD batteries	351920	
	QUADRAT SOAP DISPENSER 2030 E		Concealed installation	12V Transformer	

6-PACK LIQUID SOAP DISPENSER

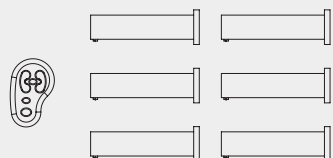
PRODUCT NAME	MODEL FEATURES	POWER SUPPLY	CODE NUMBER	DRAWING
QUADRAT SD 6-PACK B	Includes: Six (6) soap dispenser units and one (1) remote control	Battery box for six (6) DD batteries	351911	
QUADRAT SD 6-PACK E		12V Transformer	351901	
QUADRAT 2030 SD 6-PACK B		Battery box for six (6) DD batteries	351921	
QUADRAT 2030 SD 6-PACK E		12V Transformer	351931	

1.6 GALLON (6L) SOAP DISPENSER VERSIONS

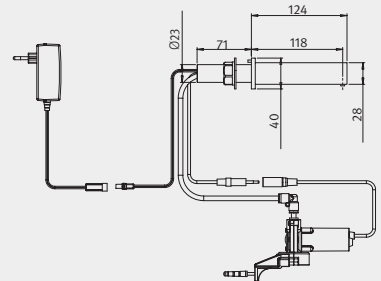
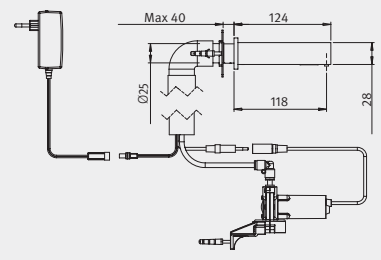
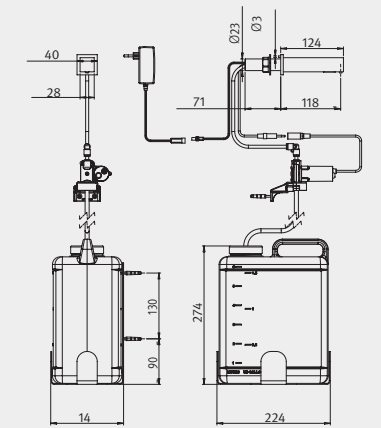
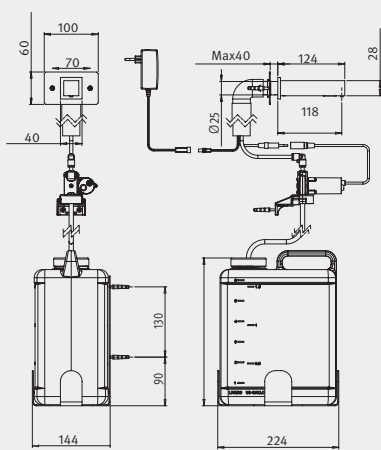
PRODUCT NAME	MODEL FEATURES	POWER SUPPLY	CODE NUMBER	DRAWING
MF QUADRAT SOAP DISPENSER	Delivers liquid soap Wall mounted touch free electronic soap dispenser to be used with Stern's Multifeed kits for multiple soap dispensers installation	12V Transformer	07292078	
MF QUADRAT SOAP DISPENSER 2030	Delivers liquid soap Wall mounted touch free electronic soap dispenser to be used with Stern's Multifeed kits for multiple soap dispensers installation	12V Transformer	07292094	
QUADRAT SD 1.6 E	Delivers liquid soap 1.6 gallon (6L) tank kit for an individual soap dispenser	12V Transformer	351916	
QUADRAT 2030 SD 1.6 E	Delivers liquid soap 1.6 gallon (6L) tank kit for an individual soap dispenser	12V Transformer	351316	

TUBULAR SOAP DISPENSER

Wall-mounted touch-free electronic soap dispenser for non-proprietary soap

Features:

- 100% heavy-duty one piece brass body
- IR sensor in dispenser spout
- Peristaltic pump

Options:



- 0.26 US gallon (1L) soap bottle
- 1.6 US gallon (6L) soap tank
- Multiple soap dispensers installation (up to six (6) dispensers) with a single 1.6 US gallon (6L) tank
- Matching IR operated faucet
- Remote control

Advantages:

- Drastically reduces soap consumption
- Cross contamination protection - no physical contact
- Clog and backflow prevention - with designated peristaltic pump
- Accurate soap dosage - adjustable by remote control
- Maximized savings - can be used with any non-proprietary soap
- Easy to install and refill
- Highly durable - for heavy traffic locations

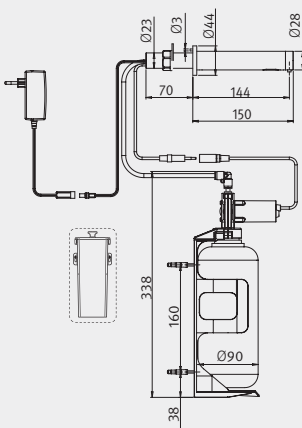

STANDARD SOAP DISPENSER VERSIONS

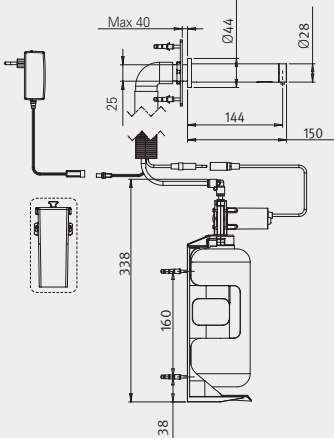
PICTURE	PRODUCT NAME	MODEL FEATURES	POWER SUPPLY	CODE NUMBER	DRAWING
	TUBULAR SOAP DISPENSER B	Delivers liquid soap Optional version: 120mm Chrome-plated 100% brass spout	Battery box for six (6) DD batteries	350920	
	TUBULAR SOAP DISPENSER E		12V Transformer	350925	
	TUBULAR SOAP DISPENSER 2030 B	Delivers liquid soap Concealed installation Optional version: 120mm Chrome-plated 100% brass spout	Battery box for six (6) DD batteries	350922	
	TUBULAR SOAP DISPENSER 2030 E		12V Transformer	350927	

STANDARD SOAP DISPENSER VERSIONS

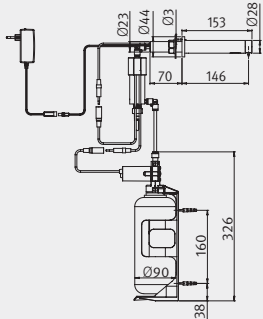
PICTURE	PRODUCT NAME	MODEL FEATURES	POWER SUPPLY	CODE NUMBER	DRAWING
	TUBULAR FOAM E	Delivers foam soap Optional version: 120mm	12V Transformer	350980	

6-PACK SOAP DISPENSER

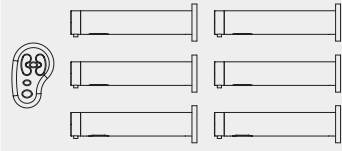
PRODUCT NAME	MODEL FEATURES	POWER SUPPLY	CODE NUMBER	DRAWING
TUBULAR SD 6-PACK B	Includes: Six (6) soap/foam dispenser units and one (1) remote control	Battery box for six (6) DD batteries	350921	
TUBULAR SD 6-PACK E		12V Transformer	350926	
TUBULAR 2030 SD 6-PACK B		Battery box for six (6) DD batteries	350923	
TUBULAR 2030 SD 6-PACK E		12V Transformer	350928	
TUBULAR FOAM 6-PACK E		12V Transformer	350981	

1.6 GALLON (6L) SOAP DISPENSER VERSIONS

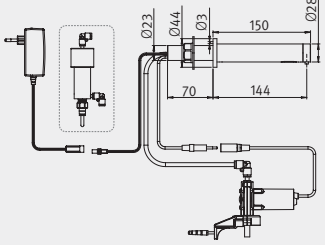
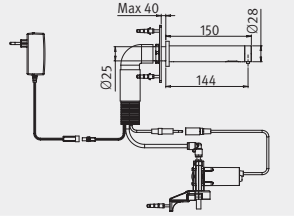
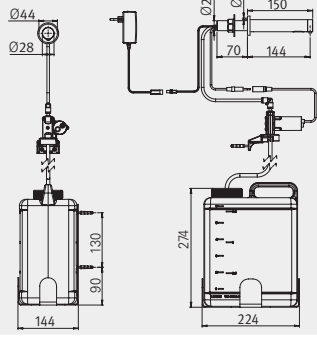
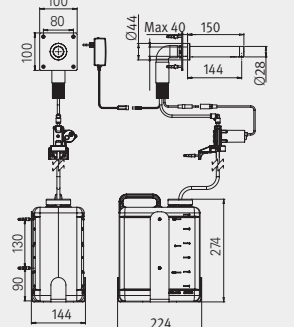
PRODUCT NAME	MODEL FEATURES	POWER SUPPLY	CODE NUMBER	DRAWING
MF TUBULAR SOAP DISPENSER	Delivers liquid soap Wall mounted touch free electronic soap dispenser to be used with Stern's Multifeed kits for multiple soap dispensers installation Optional version: 120mm	12V Transformer	07292076	
MF TUBULAR FOAM DISPENSER	Delivers foam soap Wall mounted touch free electronic soap dispenser to be used with Stern's Multifeed kits for multiple soap dispensers installation Optional version: 120mm	12V Transformer	07292186	
MF TUBULAR SOAP DISPENSER 2030	Delivers liquid soap Wall mounted touch free electronic soap dispenser to be used with Stern's Multifeed kits for multiple soap dispensers installation Optional version: 120mm	12V Transformer	07292081	
TUBULAR SD 1.6 E	Delivers liquid soap 1.6 gallon (6L) tank kit for an individual soap dispenser Optional version: 120mm	12V Transformer	350116	
TUBULAR 2030 SD 1.6 E	Delivers liquid soap 1.6 gallon (6L) tank kit for an individual soap dispenser Optional version: 120mm	12V Transformer	350816	

TUBULAR SOAP DISPENSER AISI316

Wall-mounted touch-free electronic soap dispenser for non-proprietary soap

Features:

- Stainless steel AISI316 product body
- 5-7/8" (150mm) long
- IR sensor in dispenser spout
- Peristaltic pump

Options:

- 0.26 US gallon (1L) soap bottle
- 1.6 US gallon (6L) soap tank
- Multiple soap dispensers installation (up to six (6) dispensers) with a single 1.6 US gallon (6L) tank
- Matching IR operated faucet
- Remote control

Advantages:

- Drastically reduces soap consumption
- Cross contamination protection - no physical contact
- Clog and backflow prevention - with designated peristaltic pump
- Accurate soap dosage - adjustable by remote control
- Maximized savings - can be used with any non-proprietary soap
- Easy to install and refill
- Highly durable - for heavy traffic locations



STANDARD SOAP DISPENSER VERSIONS

PICTURE	PRODUCT NAME	MODEL FEATURES	POWER SUPPLY	CODE NUMBER	DRAWING
	TUBULAR SOAP DISPENSER B AISI316	Delivers liquid soap	Battery box for six (6) DD batteries	350919	
	TUBULAR SOAP DISPENSER E AISI316		12V Transformer	350924	
	TUBULAR SOAP DISPENSER 2030 B AISI316	Delivers liquid soap Concealed installation	Battery box for six (6) DD batteries	350918	
	TUBULAR SOAP DISPENSER 2030 E AISI316		12V Transformer	350917	

STANDARD SOAP DISPENSER VERSIONS

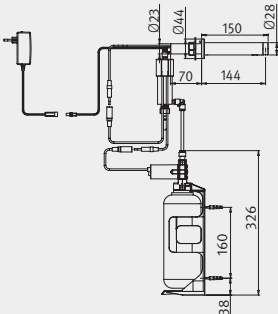
PICTURE	PRODUCT NAME	MODEL FEATURES	POWER SUPPLY	CODE NUMBER	DRAWING
	TUBULAR FOAM E AISI316	Delivers foam soap	12V Transformer	350982	

6-PACK SOAP DISPENSER

PRODUCT NAME	MODEL FEATURES	POWER SUPPLY	CODE NUMBER	DRAWING
TUBULAR SD 6-PACK B AISI316	Includes: Six (6) soap/foam dispenser units and one (1) remote control	Battery box for six (6) DD batteries	350991	
TUBULAR SD 6-PACK E AISI316		12V Transformer	350984	
TUBULAR 2030 SD 6-PACK B AISI316		Battery box for six (6) DD batteries	350992	
TUBULAR 2030 SD 6-PACK E AISI316		12V Transformer	350933	
TUBULAR FOAM 6-PACK E AISI316		12V Transformer	350983	

1.6 GALLON (6L) SOAP DISPENSER VERSIONS

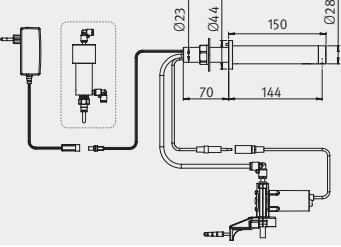
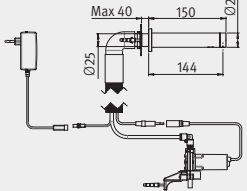
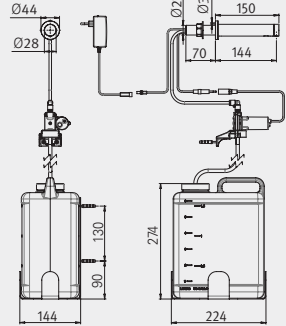
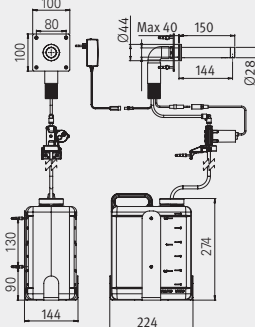
PRODUCT NAME	MODEL FEATURES	POWER SUPPLY	CODE NUMBER	DRAWING
MF TUBULAR SOAP DISPENSER AISI316	Delivers liquid soap Wall mounted touch free electronic soap dispenser to be used with Stern's Multifeed kits for multiple soap dispensers installation Optional version: 120mm	12V Transformer	07292221	
MF TUBULAR FOAM DISPENSER AISI316	Delivers foam soap Wall mounted touch free electronic soap dispenser to be used with Stern's Multifeed kits for multiple soap dispensers installation Optional version: 120mm	12V Transformer	07292231	
MF TUBULAR SOAP DISPENSER 2030 AISI316	Delivers liquid soap Wall mounted touch free electronic soap dispenser to be used with Stern's Multifeed kits for multiple soap dispensers installation Optional version: 120mm	12V Transformer	07292222	
TUBULAR SD 1.6 E AISI316	Delivers liquid soap 1.6 gallon (6L) tank kit for an individual soap dispenser Optional version: 120mm	12V Transformer	350932	
TUBULAR 2030 SD 1.6 E AISI316	Delivers liquid soap 1.6 gallon (6L) tank kit for an individual soap dispenser Optional version: 120mm	12V Transformer	350916	

EXTREME CS SOAP DISPENSER

Wall-mounted touch-free electronic soap dispenser for non-proprietary soap

Features:

- Concealed sensor integrated into the spout
- IR sensor
- Peristaltic pump
- Stainless steel AISI316 spout available

Options:

- 0.26 US gallon (1L) soap bottle
- 1.6 US gallon (6L) soap tank
- Multiple soap dispensers installation (up to six (6) dispensers) with a single 1.6 US gallon (6L) tank
- Matching IR operated faucet
- Remote control

Advantages:

- Drastically reduces soap consumption
- Cross contamination protection - no physical contact
- Clog and backflow prevention - with designated peristaltic pump
- Accurate soap dosage - adjustable by remote control
- Maximized savings - can be used with any non-proprietary soap
- Easy to install and refill
- Highly durable - for heavy traffic locations



STANDARD SOAP DISPENSER VERSION

PICTURE	PRODUCT NAME	MODEL FEATURES	POWER SUPPLY	CODE NUMBER	DRAWING
	EXTREME CS SOAP DISPENSER B	Delivers liquid soap Brass spout	Battery box for six (6) DD batteries	237891	
	EXTREME CS SOAP DISPENSER E		12V Transformer	237890	
	EXTREME CS SOAP DISPENSER B AISI316	Delivers liquid soap Stainless Steel AISI 316	Battery box for six (6) DD batteries	237891-316	
	EXTREME CS SOAP DISPENSER E AISI316		12V Transformer	237890-316	

MULTIFEED KITS



Multiple soap dispensers installation kit

Features:

- Allows multiple soap dispensers installation (up to six (6) dispensers) with a single 1.6 US gallon (6L) tank
- Stainless Steel tank support



Options:

- Anti-theft top filling mechanism for easy refill from the counter top
- Top filling mechanism with anti-theft protection
- LED light indicator of soap level
- Under-the-deck filling mechanism

Advantages:

- Drastically reduces soap consumption
- Cross contamination protection - no physical contact
- Maximized savings - can be used with any non-proprietary soap
- Easy installation
- Fast and simple refill with optional LED indication of soap level
- Highly durable - with optional vandal-resistant top-filling mechanism

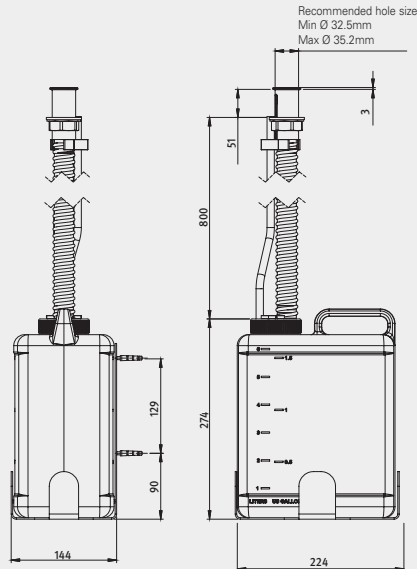
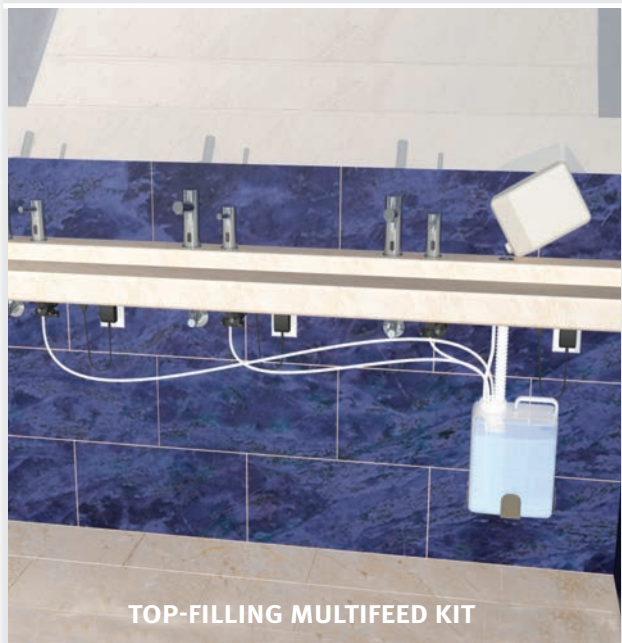
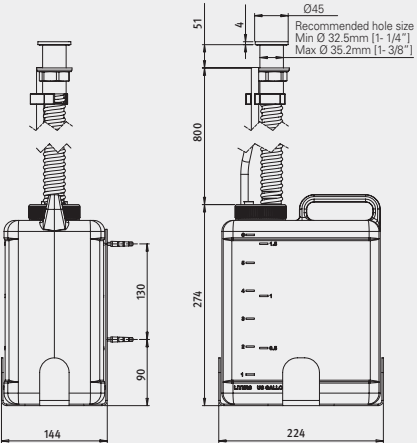

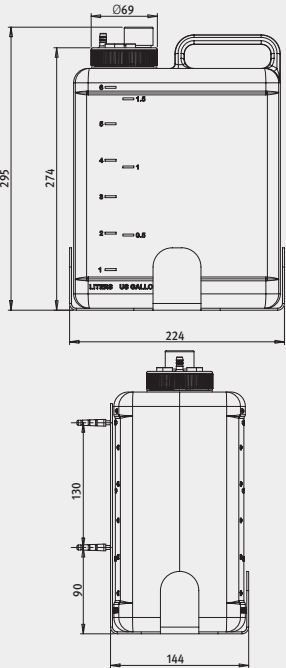
PRODUCT	MODEL FEATURES	CODE NUMBER	DRAWING
 <p data-bbox="177 719 603 775">TOP-FILLING MULTIFEED KIT WITH SOAP LEVEL INDICATOR</p>	<p data-bbox="730 338 887 591">Vandal-resistant chrome-plated top-filling brass mechanism. LED light soap level indicator. power splitter for transformer powered MF soap dispenser</p>	<p data-bbox="919 454 1010 477">07220152</p>	
 <p data-bbox="213 1384 568 1417">TOP-FILLING MULTIFEED KIT</p>	<p data-bbox="730 1016 887 1218">Vandal-resistant chrome-plated top-filling brass mechanism. Available for transformer powered MF soap dispensers</p>	<p data-bbox="919 1106 1010 1128">07220090</p>	
 <p data-bbox="185 2085 595 2119">UNDER THE DECK MULTIFEED KIT</p>	<p data-bbox="730 1626 887 1957">For multiple soap dispensers installation without connecting a top-filling mechanism through the deck. Available for transformer-powered MF soap dispensers</p>	<p data-bbox="919 1778 1010 1800">07220096</p>	

OPTIONAL: DOT ILLUMINATION FOR SOAP LEVEL INDICATION

Green: enough soap in tank
Orange: low soap level
Red: empty tank

CHROME PLATED FULL BRASS LOCKABLE COVER

MF TOUCH-FREE SOAP DISPENSER

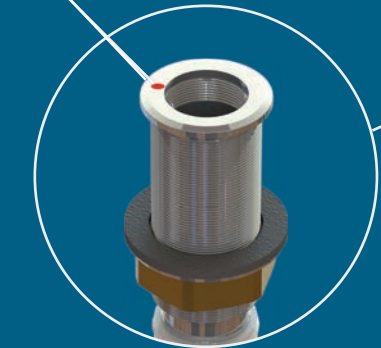

CHROME-PLATED FULL BRASS TOP-FILLING MECHANISM

BREATHE PIPE

FLEXIBLE INTAKE PIPE

SOAP COVER FOR UP TO 6 PIPES

1.6 GALLON (6L) SOAP TANK WITH STAINLESS STEEL SUPPORT

PERISTALTIC PUMP (PART OF THE MF SOAP DISPENSER)

POWER SPLITTER SOAP AND WATER

12V TRANSFORMER

TOP-FILLING MULTIFEED KIT

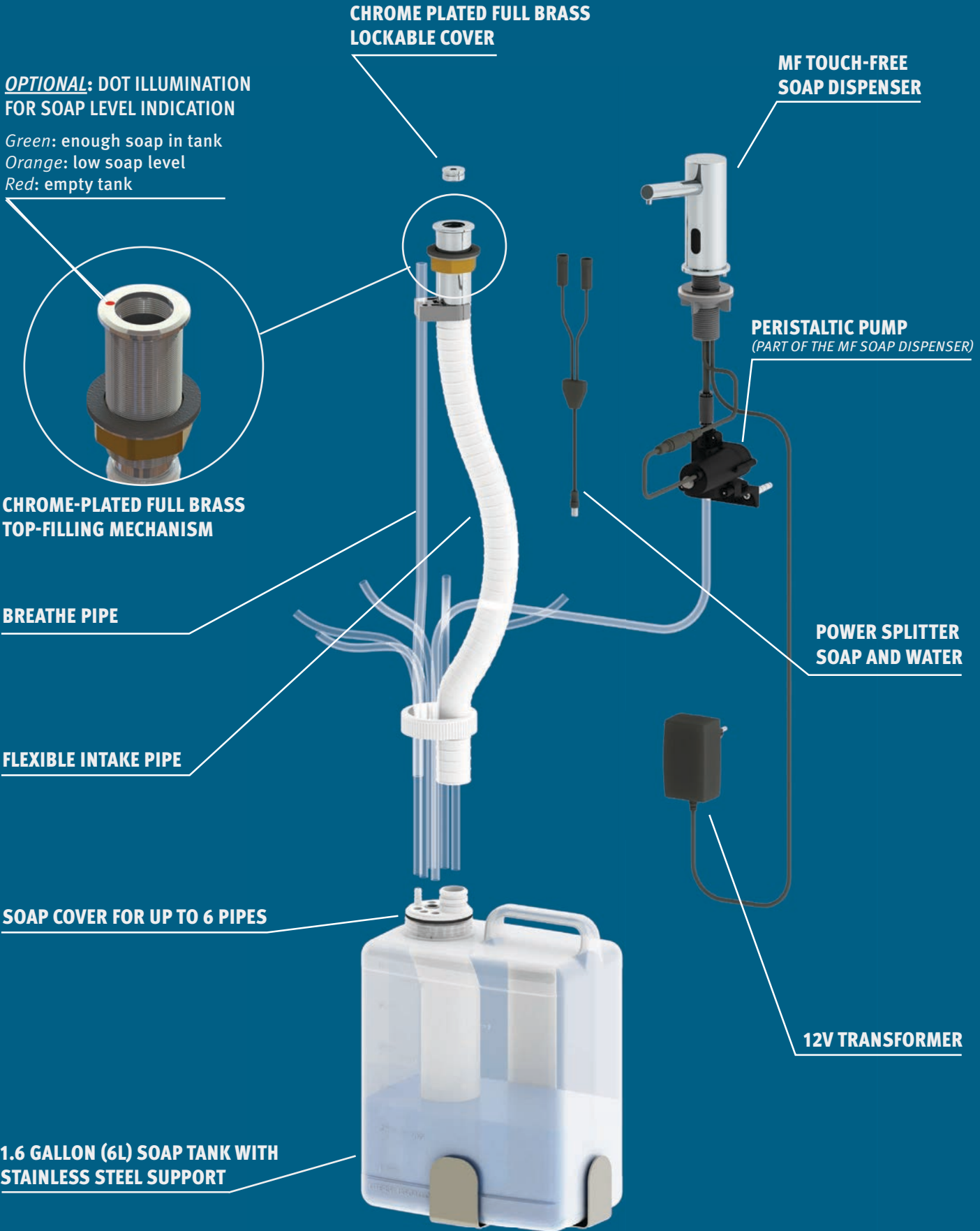

BTM SERIES

83-90



SWAR **85**
SOAP WATER AIR
REVOLUTION



SWA HI-SPEED **86**
MODULE



SWA **87-88**
SOAP WATER AIR
MODULE



BEHIND MIRROR **89**
FAUCET



BEHIND MIRROR **90**
SOAP DISPENSER

SWAR

Complete sanitary cabinet with a lockable mirror.

Includes high speed hand dryer, mixing valve, touch free faucet, touch free soap dispenser and LED pictograms for intuitive user guidance and decoration.

Delivered with remote controls to adjust soap dosage, select light color or sequence and customize the faucet settings.

- Eliminates messy, slippery floors and hand drying queues.
- Reduces the amount of labor for commercial facilities maintenance.

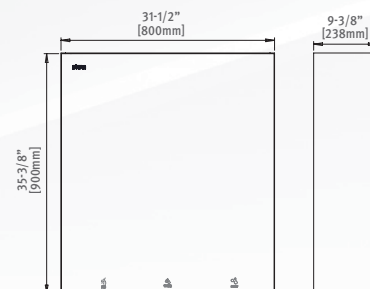
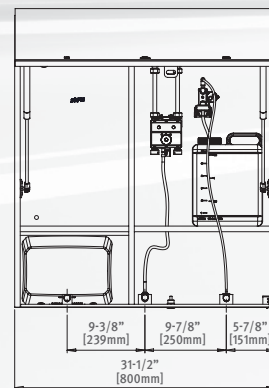

Ref: 280460
12V transformer

SWA HI-SPEED MODULE

Complete system including high speed hand dryer

- Ready to be integrated behind the mirror for a clear, minimalistic design.
- Eliminates messy, slippery floors and hand drying queues.
- Reduces the amount of labor for commercial facilities maintenance.
- Easy installation with a stainless steel frame to be fixed to the wall.
- Ideal touch free soap-water cycle.
- Helps preventing cross contamination.
- Reduces water and soap consumption.
- To be used with non-proprietary soap.
- Drying time: less than 15 seconds.

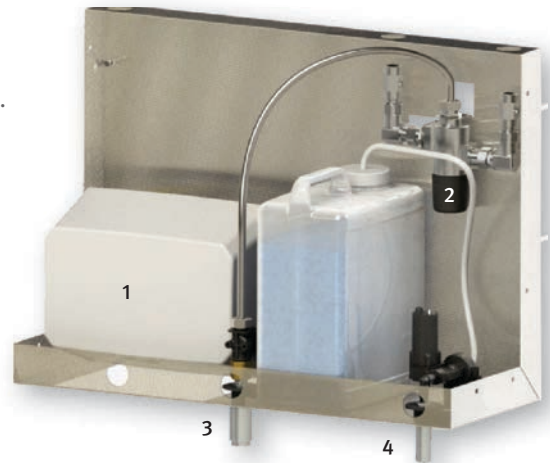

Complete system including high speed hand dryer (1), thermostatic mixing valve (2), touch free faucet (3) and liquid soap dispenser (4)

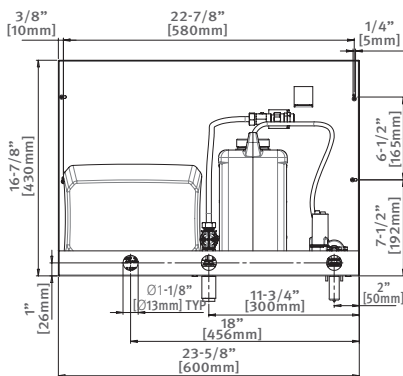

Ref: 280410
12V transformer

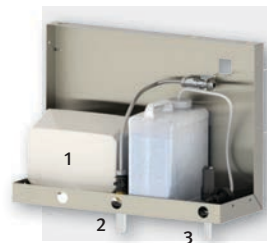

Modular system including high speed hand dryer (1), touch free faucet (2) and liquid soap dispenser (3)

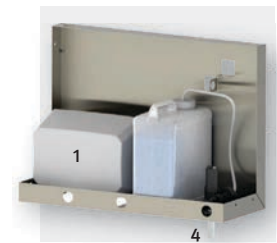

Modular system including high speed hand dryer (1) and liquid soap dispenser (4)

SWA MODULE

Electronic wall mounted system for integration behind the mirror

- Ready to be integrated behind the mirror for a clear, minimalistic design.
- Eliminates messy, slippery floors and hand drying queues.
- Reduces the amount of labor for commercial facilities maintenance.
- Easy installation with a stainless steel frame to be fixed to the wall.
- Ideal touch free soap-water-air cycle.
- Helps preventing cross contamination.
- Reduces water and soap consumption.
- To be used with non-proprietary soap.



TAILORED TO YOUR NEEDS:

The SWA Module's complete version includes a touch free soap or foam dispenser, faucet, thermostatic mixing valve and hand dryer. Each component can be delivered individually and any combination is possible.



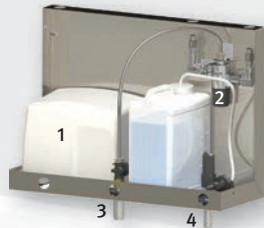

Complete system including hand dryer (1), thermostatic mixing valve (2), touch free faucet (3) and liquid soap dispenser (4)



Modular system including thermostatic mixing valve (2), touch free faucet (3) and liquid soap dispenser (4)



Modular system including hand dryer (1), touch free faucet (3) and liquid soap dispenser (4)

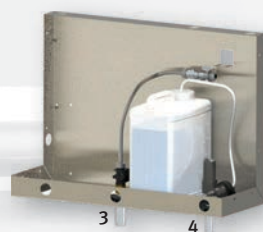
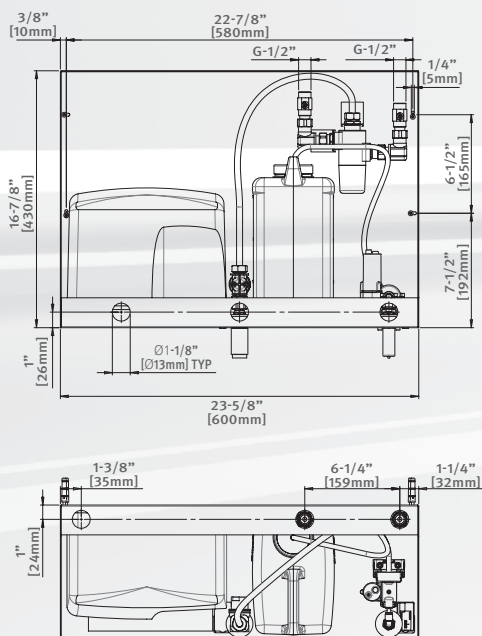

Modular system including touch free faucet (3) and liquid soap dispenser (4)



Modular system including hand dryer (1) and liquid soap dispenser (4)

Ref: 280400
12V transformer

* System including paper dispenser instead of hand dryer also available upon request

BTM FAUCET

Electronic wall mounted faucet for integration behind the mirror

- Drastically reduces water consumption.
- No physical contact. Helps to protect users against cross contamination.
- Sensor settings adjustable by remote control.
- Easy installation behind the mirror.
- Matching IR operated soap dispenser.



Ref: 280300
9V transformer

Ref: 280310
6 X 1.5V AA battery

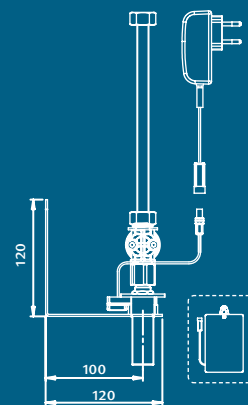

BTM SOAP DISPENSER

Touch free electronic soap dispenser for integration behind the mirror

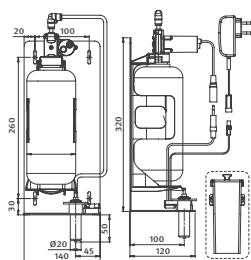

BEHIND MIRROR SD E

Liquid soap
Ref: 280200
12V transformer

BEHIND MIRROR SD B

Liquid soap
Ref: 280210
Battery box for 6xD batteries

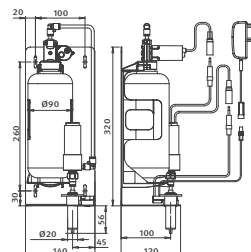

BTM FOAM E

Foam
Ref: 280250
12V transformer

BTM multifeed soap dispenser

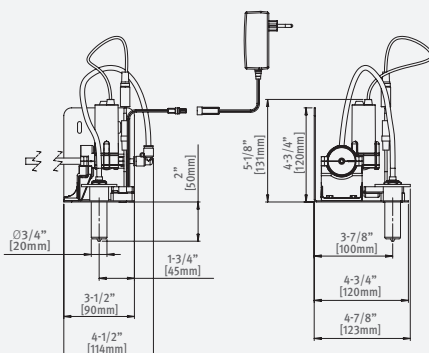

MF BEHIND MIRROR SD

Soap dispenser to be used with Stern's Multifeed kits for multiple refill. Delivers liquid soap.
Ref: 07292223
12V transformer

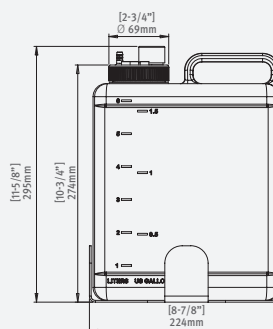

MULTIFEED KIT

This version allows multiple soap dispenser refill (up to 6 dispensers) with a single 1.6 US Gallons (6 liters) tank.
Ref: 07220096

- Drastically reduces soap consumption.
- No physical contact. Helps to protect users against cross contamination.
- Peristaltic pump. The soap is driven inside the soap tube without contact with the pump, preventing contamination and back flow.

- Accurate soap dosage.
- To be used with non-proprietary soap for maximum savings.
- Easy to install and refill.
- Matching IR operated faucet.

SHOWERS

91-106



SHOWER HEADS **93**



NEPTUNE **95-96**
SHOWER PANELS



PERFECT TIME **97-98**
SHOWER PANELS



NEPTUNE 1042T **99**



PERFECT TIME **100**
1042T



NEPTUNE MEDICAL **101**



TOUCH SH 1000T **102**



THERMIX SH 1000T **102**



NEPTUNE 1032 **103**



PERFECT TIME **103**
SH 1032



NEPTUNE 1011 **104**



PERFECT TIME 1011 **104**



FOOT WASHFREE **105**



PROX, WAVE & TOUCH **106**

SHOWER HEADS

Solid brass shower heads

Advantages:

- Drastically reduces water consumption
- Built in filter
- Silicon nozzels in spray disk for easy cleaning



LEED RATING

WATER SAVING OPTIONS		
9 LPM	2.38 GPM	FLOW RESTRICTOR
7 LPM	1.85 GPM	FLOW RESTRICTOR
6 LPM	1.59 GPM	FLOW RESTRICTOR
5 LPM	1.06 GPM	FLOW RESTRICTOR



SH 3000



SH 9000

SLEEVE KIT FOR SH 9000

PICTURE	PRODUCT NAME	MODEL FEATURES	CODE NUMBER	DRAWING
	SH 9000	Rear inlet	600400	
	SLEEVE KIT FOR SH 9000	Accessory For high security installations	07240046	
	SH 9020	Bottom inlet	600420	
	SH 3000	Top inlet	600100	

BALL VALVE

ADAPTOR FOR TRANSFORMER THREADING

ROBUST BRASS SHOWER HEAD 9000



ALUMINUM PANEL

PIEZO BUTTON

METAL THERMOSTATIC MIXING HANDLE

THERMOSTATIC CARTRIDGE INTEGRATED WITH A HOT LIMIT STOPPER

IP67 BATTERY BOX

PERFECT TIME SHOWER PANEL 1000TB



NEPTUNE

SHOWER PANELS

Electronic Shower Panel

Operated by IR sensor. Series includes options for wave or prox operation, cold or premixed water as well as thermostatic controlled hot and cold water.

Advantages:

- Drastically reduces water consumption
- No physical contact. Helps to protect users against cross contamination
- Thermostatic control for optimum temperature and scalding prevention
- Aluminum panel with Epoxy coating for high corrosion resistance
- Retrofit solution for old shower systems
Conceals damages and prevents the need of replacing tiles
- Provided shower head includes built in silicone nozzels for easy cleaning
- Default top inlet installation with options for rear inlet installation
- Sensor settings adjustable by remote control

WATER SAVING OPTIONS		
9 LPM	2.38 GPM	FLOW RESTRICTOR
7 LPM	1.85 GPM	FLOW RESTRICTOR
6 LPM	1.59 GPM	FLOW RESTRICTOR
5 LPM	1.06 GPM	FLOW RESTRICTOR



LEED RATING





PREVENT SCALDING



WAVE & PROX OPTIONS

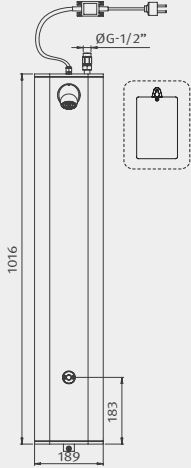

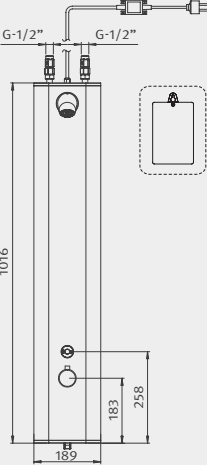
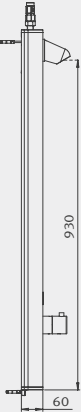
PICTURE	PRODUCT NAME	MODEL FEATURES	POWER SUPPLY	CODE NUMBER	DRAWING
	<p>NEPTUNE SHOWER PANEL B</p>	<p>Exposed installation</p> <p>Default Wave Operation: Allows activation of the shower once the users place their hands at a close proximity to the sensor. Water will shut off if the users place their hands at a close proximity to the sensor again or once a factory set flow time of 120 seconds will pass. Flow time is adjustable by remote control.</p>	<p>6 x 1.5 AA Batteries</p>	<p>601410</p>	
	<p>NEPTUNE SHOWER PANEL E</p>	<p>Optional Prox Operation: Allows automatic activation when the users are within the sensor range, and stops when the users go out of the sensor range.</p>	<p>9V Transformer</p>	<p>603410</p>	
	<p>NEPTUNE SHOWER PANEL 1000 TB</p>	<p>Exposed installation. Thermostatic mixing valve to adjust water temperature</p> <p>Default Wave Operation: Allows activation of the shower once the users place their hands at a close proximity to the sensor. Water will shut off if the users place their hands at a close proximity to the sensor again or once a factory set flow time of 120 seconds will pass. Flow time is adjustable by remote control.</p>	<p>6 x 1.5 AA Batteries</p>	<p>602410</p>	
	<p>NEPTUNE SHOWER PANEL 1000 TE</p>	<p>Optional Prox Operation: Allows automatic activation when the users are within the sensor range, and stops when the users go out of the sensor range.</p>	<p>9V Transformer</p>	<p>604410</p>	

PERFECT TIME

SHOWER PANELS

Electronically operated self closing shower panel operated by touch Operated by Piezo button/s in the shower panel.

Series includes options for cold or premixed water, long version, thermostatic controled hot and cold water, and versions with an additional hand shower.



LEED RATING







PREVENT SCALDING

WATER SAVING OPTIONS		
9 LPM	2.38 GPM	FLOW RESTRICTOR
7 LPM	1.85 GPM	FLOW RESTRICTOR
6 LPM	1.59 GPM	FLOW RESTRICTOR
5 LPM	1.06 GPM	FLOW RESTRICTOR

Advantages:

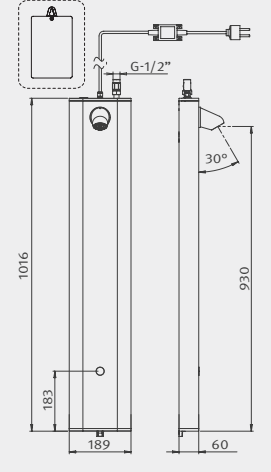
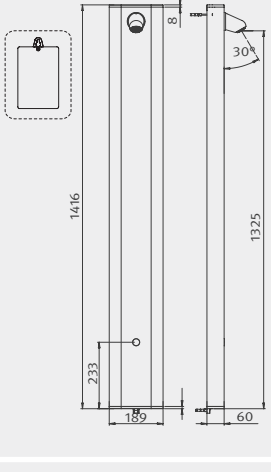
- Drastically reduces water consumption
- No moving parts, ideal for heavy duty areas
- Non hold open feature
- Thermostatic control for optimum temperature and scalding prevention (thermostatic models only)
- Aluminum panel with Epoxy coating for high corrosion resistance
- Provides a retrofit solution for old shower systems. Conceals damages and prevents the need of replacing tiles
- Retrofit solution for old shower systems
- Default top inlet installation with options for rear inlet installation
- More possibilities to save water: the water flow can be stopped in the middle of the cycle
- Stable and accurate water flow that can be changed on site

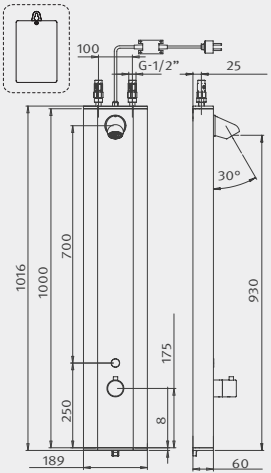

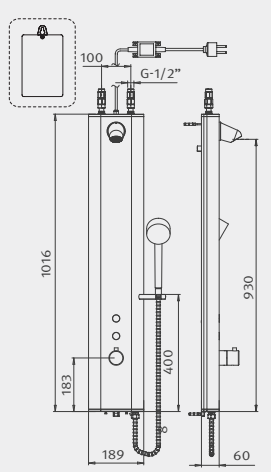
PICTURE	PRODUCT NAME	MODEL FEATURES	POWER SUPPLY	CODE NUMBER	DRAWING
	PERFECT TIME SHOWER PANEL B	Exposed installation	6 x 1.5 AA Batteries	601400	
	PERFECT TIME SHOWER PANEL E		9V Transformer	603400	
	PERFECT TIME SHOWER PANEL LB	Exposed installation. Long panel 140 mm	6 x 1.5 AA Batteries	601402	
	PERFECT TIME SHOWER PANEL 1000 TB	Exposed installation. Thermostatic mixing handle to adjust water temperature	6 x 1.5 AA Batteries	602400	
	PERFECT TIME SHOWER PANEL 1000 TE		9V Transformer	604400	
	PERFECT TIME SHOWER PANEL 1000 TB W/ HAND SHOWER	Exposed installation. Thermostatic mixing handle to adjust water temperature. Hand shower diverter	6 x 1.5 AA Batteries	602401	
	PERFECT TIME SHOWER PANEL 1000 TE W/ HAND SHOWER		9V Transformer	604401	

NEPTUNE 1042 T

ELECTRONIC SHOWER CONTROL

Operated by IR sensor.

Series includes options for wave or prox operation. Features an integrated thermostatic mixer for anti scalding operation and temperature control.

Advantages:

- Drastically reduces water consumption
- No physical contact. Helps to protect users against cross contamination.
- Thermostatic control for optimum temperature and scalding prevention
- Includes double boxing and piping, so any potential leaks drain into the shower compartment
- Metallic panel and thermostatic handle.
- Sensor settings adjustable by remote control



PICTURE	PRODUCT NAME	MODEL FEATURES	POWER SUPPLY	CODE NUMBER	DRAWING
	NEPTUNE 1042 T	<p>Concealed installation in concrete, brick walls.</p> <p>Thermostatic mixing handle to adjust water temperature</p> <p>Allows activation of the shower once the users place their hands at a close proximity to the sensor.</p> <p>Water will shut off if the users place their hands at a close proximity to the sensor again or once a factory set flow time of 120 seconds will pass.</p> <p>The flow time is adjustable on site by remote control.</p>	Internal 9V battery	612280	
	NEPTUNE 1042 TE	<p>Optional Prox Operation:</p> <p>Allows automatic activation when the users comes within the sensor range, and stops when the users leave the sensor range.</p>	9V Transformer	612281	

PERFECT TIME 1042 T

ELECTRONICALLY OPERATED SELF CLOSING
SHOWER CONTROL OPERATED BY TOUCH

Operated by a Piezo button integrated in the shower control.

Features an integrated thermostatic mixer for an anti scalding operation and temperature control.

Advantages:

- Drastically reduces water consumption
- No moving parts, ideal for heavy duty areas
- Non hold open feature
- Thermostatic control for optimum temperature and scalding prevention
- Includes double boxing and piping, so any potential leaks drain into the shower compartment
- More possibilities to save water: the water flow can be stopped in the middle of the cycle
- Stable and accurate water flow that can be changed on site
- Metallic panel and thermostatic handle.



LEED RATING



PREVENT SCALDING

PICTURE	PRODUCT NAME	MODEL FEATURES	POWER SUPPLY	CODE NUMBER	DRAWING
	<p>PERFECT TIME 1042 T</p>	<p>Concealed installation in concrete, brick walls.</p> <p>Thermostatic mixing handle to adjust water temperature</p> <p>Features an integrated piezo element.</p>	Internal 9V battery	612253	
	<p>PERFECT TIME 1042 TE</p>	<p>Touch activation</p> <p>When a user touches the designated area in the middle of the Piezo element a flow cycle of 120 seconds is completed.</p> <p>If the user does not need more water, he can touch the piezo area again to stop the water flow before the default time has passed, thus, saving more water.</p>	9V Transformer	612254	

NEPTUNE MEDICAL

ELECTRONIC SHOWER CONTROL

Operated by IR sensor. Features an integrated thermostatic mixer for anti scalding operation and temperature control.

Advantages:

- Drastically reduces water consumption
- No physical contact. Helps to protect users against cross contamination.
- Thermostatic control for optimum temperature
- Ideal for healthcare institutions
- Chrome plated brass body. Metallic thermostatic handle.
- Sensor settings adjustable by remote control
- Internal solenoid valve
- Ideal for retrofit installations



LEED RATING



PREVENT SCALDING



STERN MEDICAL



WAVE & PROX OPTIONS

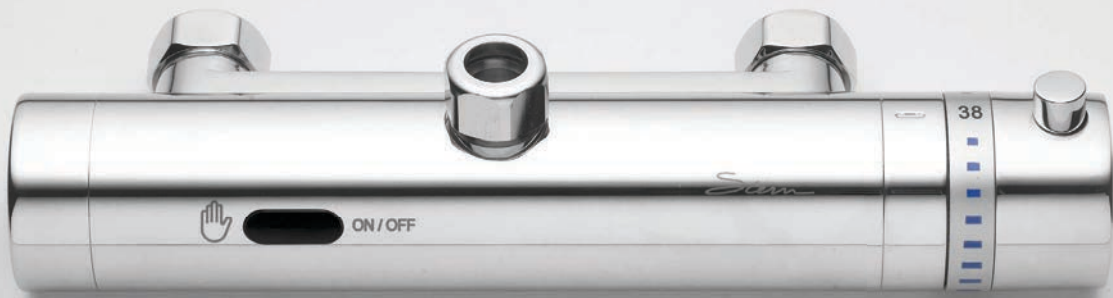

PICTURE	PRODUCT NAME	MODEL FEATURES	POWER SUPPLY	CODE NUMBER	DRAWING
	NEPTUNE MEDICAL 1000 T	<p>Exposed installation</p> <p>Allows activation of the shower once the users place their hands at a close proximity to the sensor. Water will shut off if the users place their hands at a close proximity to the sensor again or once a factory set flow time of 120 seconds will pass. Flow time is adjustable by remote control.</p> <p>Optional Prox Operation: Allows automatic activation when the users comes within the sensor range, and stops when the users leave the sensor range.</p>	Internal 9V battery	610250	
	NEPTUNE MEDICAL 1000 T BOTTOM OUTLET	<p>Exposed installation. Bottom outlet</p> <p>Exposed installation</p> <p>Allows activation of the shower once the users place their hands at a close proximity to the sensor. Water will shut off if the users place their hands at a close proximity to the sensor again or once a factory set flow time of 120 seconds will pass. Flow time is adjustable by remote control.</p> <p>Optional Prox Operation: Allows automatic activation when the users comes within the sensor range, and stops when the users leave the sensor range.</p>	Internal 9V battery	610255	

TOUCH SH 1000 T

ELECTRONICALLY OPERATED SELF CLOSING SHOWER CONTROL OPERATED BY TOUCH

Operated by a Piezo element integrated in the shower control. Features an integrated thermostatic mixer for anti scalding operation and temperature control.

Advantages:

- Drastically reduces water consumption
- No moving parts, ideal for heavy duty areas
- Non hold open feature
- Thermostatic control for optimum temperature and scalding prevention
- More possibilities to save water: the water flow can be stopped in the middle of the cycle
- Chrome plated brass body. Metallic thermostatic handle
- Stable and accurate water flow that can be changed on site
- Ideal for retrofit installations



PICTURE	PRODUCT NAME	MODEL FEATURES	POWER SUPPLY	CODE NUMBER	DRAWING
	TOUCH SH 1000 T	Exposed installation	Internal 9V battery	610710	
	TOUCH SH 1000 T BOTTOM OUTLET	Exposed installation. Bottom outlet	Internal 9V battery	610700	

THERMIX SH 1000T

NEW

SHOWER CONTROL

Wall mounted thermostatic shower control with bottom outlet. Brings and reassures safety and maximum confort to commercial or residential washrooms. The Thermix, Stern's thermostatic manual line is part of Stern's thermostatic collection.

Advantages:

- 100% chrome plated brass body
- All the parts are accesible from the front



PICTURE	PRODUCT NAME	MODEL FEATURES	CODE NUMBER	DRAWING
	THERMIX SH 1000 T	Exposed installation Manual operation	610400	

NEPTUNE 1032

ELECTRONIC SHOWER CONTROL

Operated by IR sensor.

Series includes options for wave or prox operation. Features an integrated thermostatic mixer for anti scalding operation and temperature control.

Advantages:

- Drastically reduces water consumption
- No physical contact. Helps to protect users against crosscontamination
- 100% chrome plated brass body
- Sensor settings adjustable by remote control
- Internal solenoid valve, sensor and battery. All the parts are accesible from the front



LEED RATING

WAVE & PROX OPTIONS

PICTURE	PRODUCT NAME	MODEL FEATURES	POWER SUPPLY	CODE NUMBER	DRAWING
	NEPTUNE 1032	Concealed installation in concrete, brick walls Allows activation of the shower once the users place their hands at a close proximity to the sensor. Water will shut off if the users place their hands at a close proximity to the sensor again or once a factory set flow time of 120 seconds will pass. Flow time is adjustable by remote control.	Internal 9V battery	613200	
	NEPTUNE 1032 E	Optional Prox Operation: Allows automatic activation when the users comes within the sensor range, and stops when the users leave the sensor range.	9V Transformer	613400	

PERFECT TIME SH 1032

ELECTRONICALLY OPERATED SELF CLOSING SHOWER CONTROL OPERATED BY TOUCH

Operated by a Piezo element integrated in the shower control. For cold or premixed water.

Advantages:

- Drastically reduces water consumption
- No moving parts, ideal for heavy duty areas
- Non hold open feature
- More possibilities to save water: the water flow can be stopped in the middle of the cycle
- Stable and accurate water flow that can be changed on site
- 100% chrome plated brass body
- Easy installation



LEED RATING

PICTURE	PRODUCT NAME	MODEL FEATURES	POWER SUPPLY	CODE NUMBER	DRAWING
	PERFECT TIME SH 1032	Concealed installation in concrete, brick walls	Internal 9V battery	613700	
	PERFECT TIME SH 1032 E		9V Transformer	613800	

NEPTUNE 1011

ELECTRONIC SHOWER CONTROL

Operated by IR sensor. For cold or premixed water.

Include options for wave or prox operation.

Advantages:

- Drastically reduces water consumption
- No physical contact. Helps to protect users against cross contamination
- 100% chrome plated brass body
- Sensor settings adjustable by remote control
- Internal solenoid valve



LEED RATING



WAVE & PROX OPTIONS

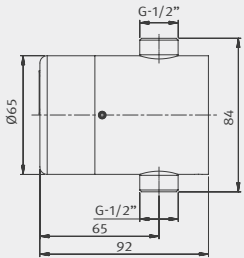

PICTURE	PRODUCT NAME	MODEL FEATURES	POWER SUPPLY	CODE NUMBER	DRAWING
	NEPTUNE 1011	<p>Exposed installation. Top nut not provided</p> <p>Allows activation of the shower once the users place their hands at a close proximity to the sensor. Water will shut off if the users place their hands at a close proximity to the sensor again or once a factory set flow time of 120 seconds will pass. Flow time is adjustable by remote control.</p> <p>Optional Prox Operation: Allows automatic activation when the users comes within the sensor range, and stops when the users leave the sensor range.</p>	Internal 9V battery	610261	

PERFECT TIME SH 1011

ELECTRONICALLY OPERATED SELF CLOSING SHOWER CONTROL OPERATED BY TOUCH

Operated by a Piezo element integrated in the shower control. For cold or premixed water.

Advantages:

- Drastically reduces water consumption
- No moving parts, ideal for heavy duty areas
- Non hold open feature
- More possibilities to save water: the water flow can be stopped in the middle of the cycle
- Stable and accurate water flow that can be changed on site
- 100% chrome plated brass body
- Easy installation



LEED RATING

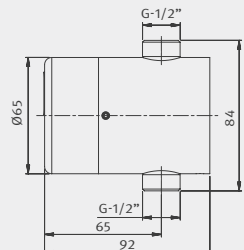

PICTURE	PRODUCT NAME	MODEL FEATURES	POWER SUPPLY	CODE NUMBER	DRAWING
	PERFECT TIME SH 1011	Exposed installation. Top nut not provided	Internal 9V battery	610600	

FOOT WASHFREE

ELECTRONICALLY OPERATED SELF CLOSING
FOOT WASHER OPERATED BY TOUCH

Operated by a Piezo element integrated in the foot washer cap.
For cold or premixed water.

Advantages:

- Drastically reduces water consumption
- No moving parts, ideal for heavy duty areas
- Non hold open feature
- More possibilities to save water: the water flow can be stopped in the middle of the cycle
- Stable and accurate water flow that can be changed on site
- Ideal for swimming pools, beaches and ritual foot washing
- Heavy duty chrome plated brass construction
- Silicone nozzles for easy cleaning
- Easy installation



LEED RATING

WATER SAVING OPTIONS		
9 LPM	2.38 GPM	FLOW RESTRICTOR
7 LPM	1.85 GPM	FLOW RESTRICTOR
6 LPM	1.59 GPM	FLOW RESTRICTOR



PICTURE	PRODUCT NAME	MODEL FEATURES	POWER SUPPLY	CODE NUMBER	DRAWING
	FOOT WASHFREE	Exposed installation	Internal 9V battery	113730	
	FOOT WASHFREE 3000	Exposed installation. Directional shower head	Internal 9V battery	113720	

PROX, WAVE & TOUCH SOLUTIONS



TOUCH FREE & TOUCH OPERATED SHOWER KITS

Operated by an IR sensor or a Piezo button. Can be integrated with a shower panel, shower control or as an individual unit. For cold or premixed water.







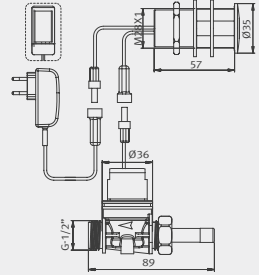

Advantages:

TOUCH FREE OPERATION:

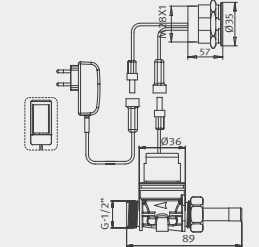
- Drastically reduces water consumption
- No physical contact. Helps to protect users against cross contamination
- Sensor settings adjustable by remote control

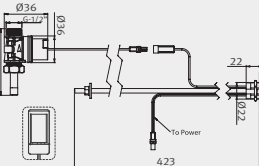
TOUCH OPERATION:

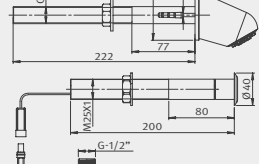
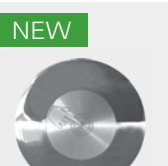
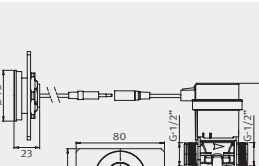
- Drastically reduces water consumption
- Non hold open feature
- More possibilities to save water: the water flow can be stopped in the middle of the cycle
- Stable and accurate water flow that can be changed on site

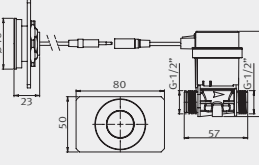
PICTURE	PRODUCT NAME	MODEL FEATURES	POWER SUPPLY	CODE NUMBER	DRAWING
	PROX KIT FOR SHOWER	<p>Concealed installation in dry or plaster wall. Option for front fixation installation in concrete, brick walls.</p> <p>Touch free Prox Operation Allows automatic activation when the users bring their hands within the sensor range, and stops when the users remove their hands.</p>	9V battery / 9V transformer	620000	
	WAVE KIT FOR SHOWER	<p>Concealed installation in dry or plaster wall. Option for front fixation installation in concrete, brick walls.</p> <p>Touch free Wave Operation Allows activation of the shower once the users place their hands at a close proximity to the sensor.</p> <p>Water will shut off if the users place their hands at a close proximity to the sensor again or once a factory set flow time of 120 seconds will pass. Flow time is adjustable by remote control.</p>	9V battery / 9V transformer	620810	
	PROGRAMMABLE PIEZO KIT FOR SHOWER	<p>Concealed installation in dry or plaster wall. Option for front fixation installation in concrete, brick walls.</p> <p>Touch Operation Allows activation of the shower / unit once the users touch the designated area in the Piezo button. Water will shut off if the users touch the designated area again or once a factory set flow time of 120 seconds will pass.</p>	9V battery / 9V transformer	07225019	
	APS THREADED ROD KIT SHOWER	<p>Threaded rod solution for piezo kits installations in thick walls. Kit includes Piezo switch, threaded rod with rosette and solenoid valve.</p> <p>Touch Operation Allows activation of the shower / unit once the users touch the designated area in the Piezo button. Water will shut off if the users touch the designated area again or once a factory set flow time of 120 seconds will pass.</p>	9V battery / 9V transformer	07226054	
	PPS HIGH SECURITY KIT FOR SHOWER	<p>Specially designed for high security environments. The kit includes a shower head and piezo switch that are incorporated in a brass sleeve.</p> <p>For concealed installation in concrete, brick walls.</p>	Not included	07226033	
NEW 	PROGRAMMABLE PIEZO KIT FOR BEACH SHOWER COLUMNS	<p>Self-closing piezo kit for showers. Activated by touching the designated area. Kit includes a programmable piezo switch, solenoid valve with housing. Filter and valve are located in the IP67 waterproof dual power input box. The shower will automatically shut off after a factory set flow time of 30 seconds would pass. Flow time adjustable on site if required. Dual power input box can be used to operate the product by battery or transformer. When used with a transformer it has an integrated automatic battery backup.</p>	9V battery / 9V transformer	07226050	

URINALS & TOILETS

107-126



JUPITER 2040 **109**



NARA 2030 **110**



JUPITER 1032 **111**



JUPITER 1011 **111**



FREE SERIES **112**



JUPITER 3002 **113**



PROX FOR URINALS **114**



NARA 2032 **115-117**



NARA 2022 **118**



VENUS COMFORT 2032 **119**



VENUS COMFORT 2032 DF **120**



PERFECT TIME 2032 **120**



VENUS 3002 **121**



APS KIT FOR TOILETS WITH DISTANT CONTROL **122**



PROX, WAVE & TOUCH SOLUTIONS FOR TOILET **123**



PROX & WAVE SENSOR KIT FOR TOILET **124**



ELECTROMAGNETIC CISTERN SYSTEM **125-126**

JUPITER 2040 SERIES

Concealed electronic flush valve for urinal operated by IR sensor.
Flushing duration and other settings are adjustable by remote control.

Advantages:

- Drastically reduces water consumption
- No physical contact. Helps to protect users against cross contamination
- Stainless steel AISI316 panel
- Sensor settings adjustable by remote control
- Easy installation

Hygiene Flush: To maximize hygiene, this product is equipped with a 24 hours duty flush. The flush takes place after 24 hours of non use have passed. Prevents the trap seal from drying out, possible freezing of pipes, and gets rid of potential bacteria in stuck water. This function can be disabled using the remote control.





LEED RATING



IRON FRAME AVAILABLE

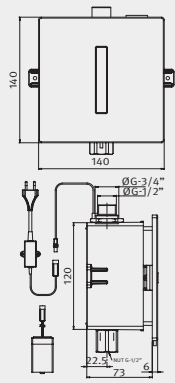

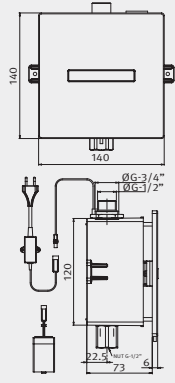
PICTURE	PRODUCT NAME	MODEL FEATURES	POWER SUPPLY	CODE NUMBER	DRAWING
	JUPITER 2040	Iron frame available. See also page 127	Internal 9V battery	125900	
	JUPITER 2040 E		9V Transformer	125901	
	JUPITER 2040 H	Iron frame available. See also page 127	Internal 9V battery	125910	
	JUPITER 2040 HE		9V Transformer	125911	

NARA 2030 SERIES

Concealed electronic flush valve for urinal operated by IR sensor.
Flushing duration and other settings are adjustable by remote control.

Advantages:

- Drastically reduces water consumption
- No physical contact. Helps to protect users against cross contamination
- Sensor settings adjustable by remote control
- Easy installation
- Matching flush valve for toilets available.

Hygiene Flush: To maximize hygiene, this product is equipped with a 24 hours duty flush. The flush takes place after 24 hours of non use have passed. Prevents the trap seal from drying out, possible freezing of pipes, and gets rid of potential bacteria in stuck water. This function can be disabled using the remote control.



LEED RATING



IRON FRAME AVAILABLE

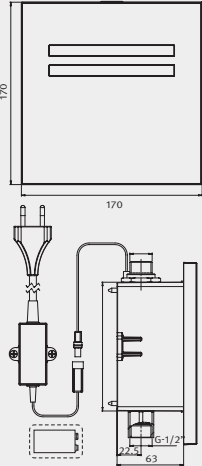

PICTURE	PRODUCT NAME	MODEL FEATURES	POWER SUPPLY	CODE NUMBER	DRAWING
	NARA 2030	Iron frame available. See also page 127	Internal 9V battery	170200	
	NARA 2030 E		9V Transformer	170100	

JUPITER 1032 SERIES

Concealed electronic flush valve for urinal operated by IR sensor.
Flushing duration and other settings are adjustable by remote control.

Advantages:

- Drastically reduces water consumption
- No physical contact. Helps to protect users against cross contamination
- 100 % brass chrome plated body
- Sensor settings adjustable by remote control



Hygiene Flush: To maximize hygiene, this product is equipped with a 24 hours duty flush. The flush takes place after 24 hours of non use have passed. Prevents the trap seal from drying out, possible freezing of pipes, and gets rid of potential bacteria in stuck water. This function can be disabled using the remote control.



LEED RATING

PICTURE	PRODUCT NAME	MODEL FEATURES	POWER SUPPLY	CODE NUMBER	DRAWING
	JUPITER 1032	Concealed installation	Internal 9V battery	134510	
	JUPITER 1032 E		9V Transformer	134520	

JUPITER 1011

EXPOSED ELECTRONIC FLUSH VALVE FOR URINAL

Operated by IR sensor.
Flushing duration and other settings are adjustable by remote control.

Advantages:

- Drastically reduces water consumption
- No physical contact. Helps to protect users against cross contamination
- 100 % brass chrome plated body
- Sensor settings adjustable by remote control
- Easy installation



Hygiene Flush: To maximize hygiene, this product is equipped with a 24 hours duty flush. The flush takes place after 24 hours of non use have passed. Prevents the trap seal from drying out, possible freezing of pipes, and gets rid of potential bacteria in stuck water. This function can be disabled using the remote control.



LEED RATING

PICTURE	PRODUCT NAME	MODEL FEATURES	POWER SUPPLY	CODE NUMBER	DRAWING
	JUPITER 1011	Exposed installation. (Pipes not supplied)	Internal 9V battery	132100	

FREE SERIES

Exposed electronic flush valve for urinal operated by IR sensor.
Flushing duration and other settings are adjustable by remote control.

Advantages:

- Drastically reduces water consumption
- No physical contact. Helps to protect users against cross contamination
- 100 % brass chrome plated body
- Sensor settings adjustable by remote control
- Easy installation

Hygiene Flush: To maximize hygiene, this product is equipped with a 24 hours duty flush. The flush takes place after 24 hours of non use have passed. Prevents the trap seal from drying out, possible freezing of pipes, and gets rid of potential bacteria in stuck water. This function can be disabled using the remote control.



LEED RATING



PICTURE	PRODUCT NAME	MODEL FEATURES	POWER SUPPLY	CODE NUMBER	DRAWING
	FREE	Standard	Internal 9V battery	113100	
	FREE E		9V Transformer	113200	
	FREE SP	Includes a 200 mm bended pipe and spray. Option for a 300 mm pipe.	Internal 9V battery	800504	

JUPITER 3002 SERIES

Exposed electronic flush valve for urinal operated by IR sensor.

Includes a manual override flush activator button, integral flow regulator, in line filter, high pressure vacuum breaker and adjustable tail piece. Flushing duration and other settings are adjustable by remote control.

Advantages:

- Drastically reduces water consumption
- No physical contact. Helps to protect users against cross contamination.
- 100% brass chrome plated body
- Sensor settings adjustable by remote control
- Easy installation



Hygiene Flush: To maximize hygiene, this product is equipped with a 24 hours duty flush. The flush takes place after 24 hours of non use have passed. Prevents the trap seal from drying out, possible freezing of pipes, and gets rid of potential bacteria in stuck water. This function can be disabled using the remote control.



LEED RATING

PICTURE	PRODUCT NAME	MODEL FEATURES	POWER SUPPLY	CODE NUMBER	DRAWING
	JUPITER M 0.5 GPF	Side inlet. Manual override flush activator button.	Internal 9V battery	140112	
	JUPITER ME 0.5 GPF	Specially designed for the needs of the North American market	9V Transformer	140516	
	JUPITER 3002 M	Rear inlet. Manual override flush activator button	Internal 9V battery	140215	
	JUPITER 3002 EM		9V Transformer	140315	

PROX SOLUTIONS

Electronic flush valve kit for urinal.

Flushing duration and other settings are adjustable by remote control.

Advantages:

- Drastically reduces water consumption
- No physical contact. Helps to protect users against cross contamination
- 100% brass chrome plated body
- Sensor settings adjustable by remote control
- Easy installation

Hygiene Flush: To maximize hygiene, this product is equipped with a 24 hours duty flush. The flush takes place after 24 hours of non use have passed. Prevents the trap seal from drying out, possible freezing of pipes, and gets rid of potential bacteria in stuck water. This function can be disabled using the remote control.



LEED RATING



PICTURE	PRODUCT NAME	MODEL FEATURES	POWER SUPPLY	CODE NUMBER	DRAWING
	PROX KIT FOR URINAL	Suitable for duct concealed installations (plaster walls)	9V Battery / 9V Transformer	620700	
	PROX FRONT FIXATION KIT FOR URINALS	Suitable for concrete walls installation	9V Battery / 9V Transformer	620750	

NARA 2032 SERIES

Concealed electronic flush valve for toilet operated by IR sensor. Features a dual flush IR system.

Includes models with a Piezo override flush activator switch giving the user the possibility of alternative manual touch activation.

Flushing duration and other settings are adjustable by remote control.

Advantages:

- Drastically reduces water consumption
- No physical contact. Helps to protect users against cross contamination
- Sensor settings adjustable by remote control
- Easy installation
- Matching flush valve for urinals available.

Hygiene Flush: To maximize hygiene, this product is equipped with a 24 hours duty flush. The flush takes place after 24 hours of non use have passed. Prevents the trap seal from drying out, possible freezing of pipes, and gets rid of potential bacteria in stuck water. This function can be disabled using the remote control.





LEED RATING





IRON FRAME AVAILABLE

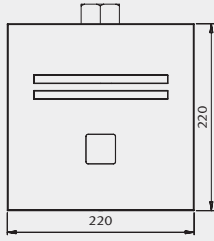

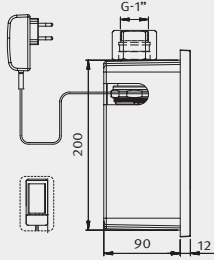
ELECTRONIC FLUSH VALVE WITH A MANUAL OVERRIDE FLUSH BUTTON

PICTURE	PRODUCT NAME	MODEL FEATURES	POWER SUPPLY	CODE NUMBER	DRAWING
	NARA 2032	Dual Flush. Features a mechanical override flush activator button. Iron frame available. See also page 127	9V Battery	160310	
	NARA 2032 E	Water will flush after the user moves away from the toilet. If the user spends less than one minute in front of the sensor, a half flush (3 liters) will take place. For more than one minute, a full flush (6 liters) will take place.	9V Transformer	160410	
	NARA ECO 2032	Dual Flush. Features a mechanical override flush activator button. Iron frame available. See also page 127	9V Battery	160320	
	NARA ECO 2032 E	Water will flush after the user moves away from the toilet. If the user spends less than one minute in front of the sensor, a half flush (3 liters) will take place. For more than one minute, a full flush (4.5 liters) will take place.	9V Transformer	160330	

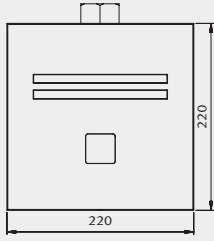
ELECTRONIC FLUSH VALVE WITH A TOUCH FLUSH BUTTON

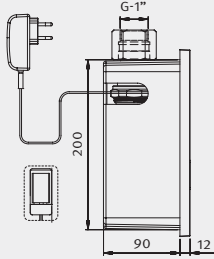
PICTURE	PRODUCT NAME	MODEL FEATURES	POWER SUPPLY	CODE NUMBER	DRAWING
	NARA 2032 P	Dual Flush. Features a touch flush activator button. Iron frame available. See also page 127	9V Battery	160610	
	NARA 2032 PE	Water will flush after the user moves away from the toilet. If the user spends less than one minute in front of the sensor, a half flush (3 liters) will take place. For more than one minute, a full flush (6 liters) will take place.	9V Transformer	160510	
	NARA ECO 2032 PE	Dual Flush. Features a touch flush activator button. Iron frame available. See also page 127 Water will flush after the user moves away from the toilet. If the user spends less than one minute in front of the sensor, a half flush (3 liters) will take place. For more than one minute, a full flush (4.5 liters) will take place.	9V Transformer	160340	

ACCESSORIES

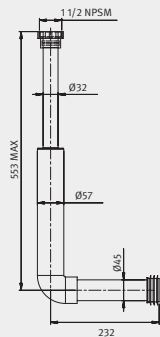
PRODUCT NAME	MODEL FEATURES	CODE NUMBER	DRAWING
SET OF PIPES	Set of pipes for in wall installation	07291037	

SHUT OFF VALVE

IR SENSOR:

- a. Dual flush program
- b. Hygiene flush function (disabled)
- c. Sensor functions adjustable by remote control

9V BATTERY BOX

BOX FOR CONCEALED INSTALLATION

METAL PANEL

with a mechanical override button

FLUSH VALVE

REMOTE CONTROL

SET OF PIPES

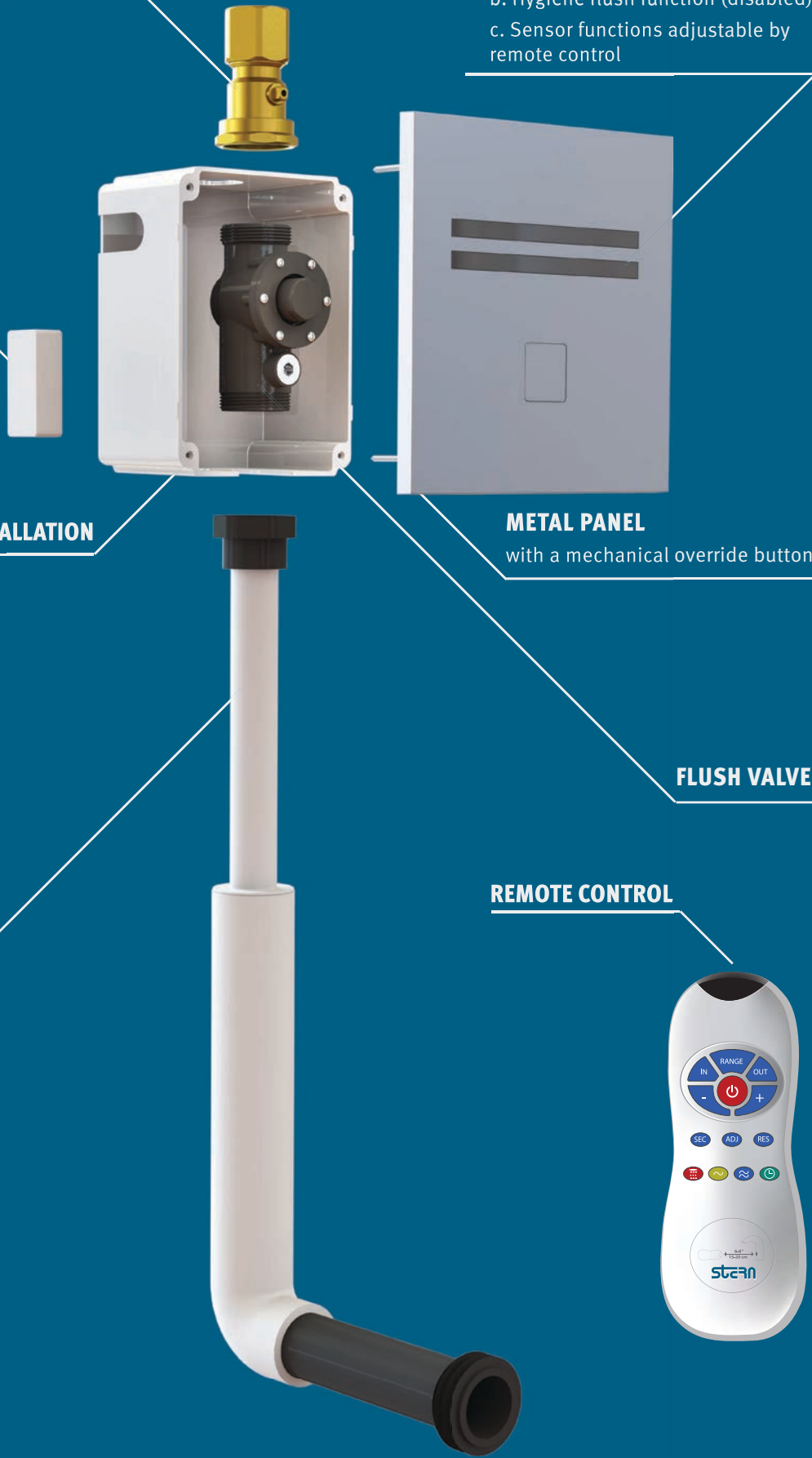

NARA 2022 SERIES

Concealed electronic flush valve for toilet operated by IR sensor. Dual flush IR system upon request. Includes an hydraulic override flush activator button.

Flushing duration and other settings are adjustable by remote control.

Advantages:

- Drastically reduces water consumption
- No physical contact. Helps to protect users against cross contamination.
- Sensor settings adjustable by remote control
- Easy installation
- Matching flush valve for urinals available.

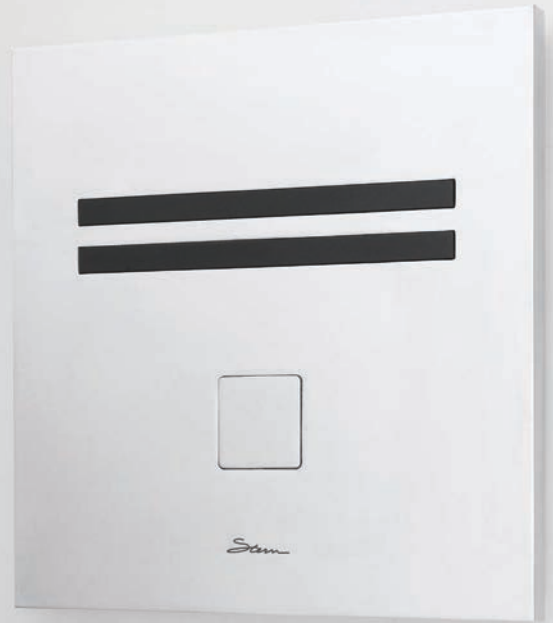

Hygiene Flush: To maximize hygiene, this product is equipped with a 24 hours duty flush. The flush takes place after 24 hours of non use have passed. Prevents the trap seal from drying out, possible freezing of pipes, and gets rid of potential bacteria in stuck water. This function can be disabled using the remote control.



LEED RATING



IRON FRAME AVAILABLE

PICTURE	PRODUCT NAME	MODEL FEATURES	POWER SUPPLY	CODE NUMBER	DRAWING
	NARA 2022	Dual flush. Features an hydraulic override flush activator button	9V Battery	160750	
	NARA 2022 E		9V Transformer	160700	

ACCESSORIES

PRODUCT NAME	MODEL FEATURES	CODE NUMBER	DRAWING
SET OF PIPES	Set of pipes for in wall installation	07291037	

VENUS COMFORT 2032 SERIES

Concealed electronic flush valve for toilet operated by IR sensor. Dual flush IR system upon request. Includes models with a Piezo override flush activator switch, giving the user the possibility of alternative flushing with an easy touch activation.

Flushing duration and other settings are adjustable by remote control.

Advantages:

- Drastically reduces water consumption
- No physical contact. Helps to protect users against cross contamination.
- Stainless steel AISI316 panel
- Sensor settings adjustable by remote control
- Easy installation

Hygiene Flush: To maximize hygiene, this product is equipped with a 24 hours duty flush. The flush takes place after 24 hours of non use have passed. Prevents the trap seal from drying out, possible freezing of pipes, and gets rid of potential bacteria in stuck water. This function can be disabled using the remote control.







LEED RATING

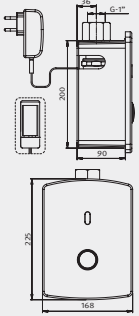

IRON FRAME AVAILABLE

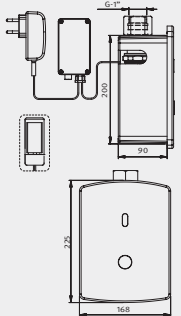

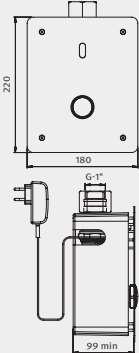
PICTURE	PRODUCT NAME	MODEL FEATURES	POWER SUPPLY	CODE NUMBER	DRAWING
	VENUS COMFORT 2032	Optional dual flush. Features a manual override flush activator button. Iron frame available. See also page 127	9V Battery	410562	
	VENUS COMFORT 2032 E		9V Transformer	410541	
	VENUS COMFORT 2032 P	Optional dual flush. Features a piezo override flush activator button. Iron frame available. See also page 127	9V Battery	410576	
	VENUS COMFORT 2032 PE		9V Transformer	410546	
	VENUS XS 2032E	Features a manual override flush activator button.	9V Transformer	410601	

VENUS COMFORT 2032 DF

Concealed electronic self closing flush valve for toilet operated by touch.
 Features two Piezo switches integrated in the panel for dual flush operation.
 Flushing duration can be changed on site according to the specific site requirements.

Advantages:

- Drastically reduces water consumption
- No moving parts, ideal for heavy duty areas
- Non hold open feature
- Easy touch activation to allow use by young children, elderly and disabled people
- Stainless steel AISI316 panel
- Easy installation

Hygiene Flush: To maximize hygiene, this product is equipped with a 24 hours duty flush. The flush takes place after 24 hours of non use have passed. Prevents the trap seal from drying out, possible freezing of pipes, and gets rid of potential bacteria in stuck water. This function can be disabled using the remote control.



LEED RATING



IRON FRAME AVAILABLE



PICTURE	PRODUCT NAME	MODEL FEATURES	POWER SUPPLY	CODE NUMBER	DRAWING
	VENUS COMFORT 2032 DF	Dual Flush Iron frame available. See also page 127	9V Battery	410446	
	VENUS COMFORT 2032 DFE	The system delivers a reduced 3 liters flush when the user touches the one (1) wave button and a full 6 liters flush when the user touches the two (2) waves button.	9V Transformer	410447	

PERFECT TIME 2032

Concealed electronic self closing flush valve for toilet operated by touch.
 Features a Piezo switch integrated in the panel. Flushing duration can be changed on site according to the specific site requirements.

Advantages:

- Drastically reduces water consumption
- No moving parts, ideal for heavy duty areas
- Non hold open feature
- Easy touch activation to allow use by young children, elderly and disabled people
- Stainless steel AISI316 panel
- Easy installation



LEED RATING



IRON FRAME AVAILABLE



PICTURE	PRODUCT NAME	MODEL FEATURES	POWER SUPPLY	CODE NUMBER	DRAWING
	PERFECT TIME 2032 E	Iron frame available. See also page 127	9V Transformer	410761	

VENUS 3002 SERIES

Exposed electronic flush valve for toilet operated by IR sensor. Includes a manual override flush activator button, integral flow regulator, in line filter, high pressure vacuum breaker and adjustable tail piece. Flushing duration and other settings are adjustable by remote control.

Advantages:

- Drastically reduces water consumption
- No physical contact. Helps to protect users against cross contamination.
- 100 % brass chrome plated body
- Sensor settings adjustable by remote control
- Easy installation

Hygiene Flush: To maximize hygiene, this product is equipped with a 24 hours duty flush. The flush takes place after 24 hours of non use have passed. Prevents the trap seal from drying out, possible freezing of pipes, and gets rid of potential bacteria in stuck water. This function can be disabled using the remote control.



LEED RATING



IRON FRAME AVAILABLE



PICTURE	PRODUCT NAME	MODEL FEATURES	POWER SUPPLY	CODE NUMBER	DRAWING
	VENUS 1.28 GPF	Side inlet. Specially designed for the needs of the North American market	Internal 9V battery	420242	
	VENUS E 1.28 GPF		9V Transformer	420232	
	VENUS 3002 R	Side inlet. Manual override flush activator button Allows automatic activation when the users have left the toilet.	Internal 9V battery	420241	
	VENUS 3002 RE		9V Transformer	420265	
	VENUS 3003R PE	Designated for high security locations. Operated by remote activation Piezo button located in the inmate's cell, while the flush valve body is concealed in the service area. Each activation gives a pre-set run cycle Allows activation of the toilet once the user touches the designated area in the Piezo button.	9V Transformer	420280	
	VENUS 3002	Rear inlet. Features a mechanical override push button to enable manual operation. Dual flush version available.	Internal 9V battery	420255	
	VENUS 3002 E		9V Transformer	420231	

APS KIT FOR TOILETS WITH DISTANT CONTROL

Electronically operated self closing flush valve for toilet with distant control, designated for special needs or high security locations. Can be operated by a Piezo button located in the toilet area, or using the remote panel for alternative operation. Each activation gives a pre-set run cycle.



Advantages:

- Drastically reduces water consumption
- No moving parts, ideal for heavy duty areas
- Non hold open feature
- Easy touch activation to allow use by young children, elderly and disabled people
- Stainless steel AISI316 panel
- Easy installation

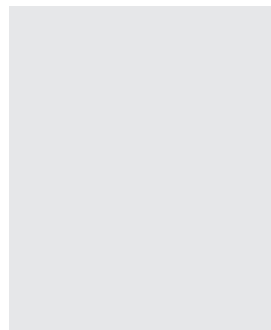

LEED RATING

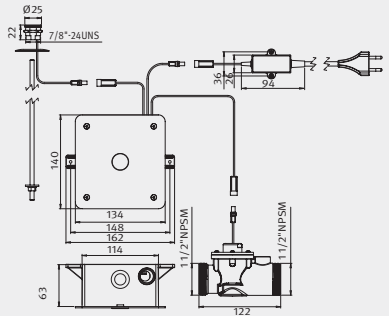

PICTURE	PRODUCT NAME	MODEL FEATURES	POWER SUPPLY	CODE NUMBER	DRAWING
	PIEZO KIT FOR W.C. WITH DISTANT CONTROL	Suitable for duct concealed installations (plaster walls) Default Special needs version: Includes a BPS Piezo switch to be installed in the toilet area for standard operation and a remote panel to be installed in a remote location for an alternative easy activation.	9V transformer	07226042	
		Suitable for duct concealed installations (plaster walls) Optional High security version: Includes a BPS switch located in the inmate's cell that allows to flush the toilet, while the flush valve body is concealed in the service area. The remote panel, installed outside the cell, allows disabling the system to perform sudden search procedures for drugs or weapons. Includes a Red ring of light indication when the system is disabled. Once disabled, the system can be enabled manually by the prison personnel or automatically after one hour.			

PROX, WAVE & TOUCH SOLUTIONS

Touch free & Touch operated flush valve for toilet kits.

Electronic modular flush valve for toilet for installation in the wall or panel.
Flushing duration and other settings are adjustable by remote control.

Advantages:

TOUCH FREE OPERATION:

- Drastically reduces water consumption
- No physical contact. Helps to protect users against cross contamination.
- 100 % brass chrome plated housing
- Sensor settings adjustable by remote control
- Easy installation

TOUCH OPERATION:

- Drastically reduces water consumption
- Non hold open feature
- Stable and accurate water flow that can be changed on site
- 100 % brass chrome plated housing
- Easy installation

Hygiene Flush: To maximize hygiene, this product is equipped with a 24 hours duty flush. The flush takes place after 24 hours of non use have passed. Prevents the trap seal from drying out, possible freezing of pipes, and gets rid of potential bacteria in stuck water. This function can be disabled using the remote control.





LEED RATING



WAVE & PROX OPTIONS

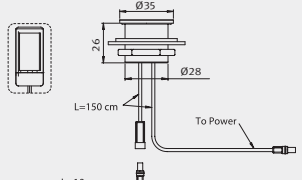

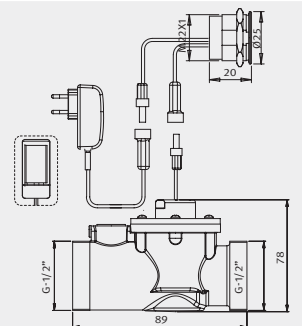
PICTURE	PRODUCT NAME	MODEL FEATURES	POWER SUPPLY	CODE NUMBER	DRAWING
	PROX KIT FOR TOILETS	Suitable for duct concealed installations (plaster walls) Touch free Prox Operation Allows automatic activation when the users have left the toilet.	9V Battery / 9V Transformer (not included)	620100	
	WAVE ON/OFF SENSOR KIT FOR TOILET	Suitable for duct concealed installations (plaster walls) Touch free Wave Operation Allows flushing of the toilet once the users place their hands at a close proximity.	9V Battery / 9V Transformer (not included)	620600	
	APS KIT FOR TOILETS	Suitable for duct concealed installations (plaster walls) Touch Operation Allows activation of the toilet once the users touch the designated area in the Piezo button.		07225018	

PROX & WAVE SENSOR KIT FOR TOILET WITH PRIMARY FLUSH

This kit is designed to operate a two volumes flush valve. The sensor detects the user at a given distance, and operates an automatic flush using the sensor's prox function once the user has left the toilet. Depending on time and distance, the systems delivers 3 liters to evacuate liquids and 6 liters to evacuate solids. To maximize hygiene, the system allows the user upon arriving to the toilet to operate a primary cleaning flush using the sensor's wave function.

Optional hygiene flush of 24, 48 or 72 hours to be set with the Stern remote control.

Advantages:

- Drastically reduces water consumption
- No physical contact. Helps to protect users against cross contamination.
- Primary cleaning flush upon presentation of hand
- Hygiene flush of 24, 48 or 72 hours.
- Options for duct concealed and brick wall (front fixation) installations.
- Water saving dual flush performance
- Bespoke settings adjustable with the Stern remote control
- Maximum achievement of LEED points



Hygiene Flush: To maximize hygiene, this product is equipped with a 24 hours duty flush. The flush takes place after 24 hours of non use have passed. Prevents the trap seal from drying out, possible freezing of pipes, and gets rid of potential bacteria in stuck water. This function can be disabled using the remote control.



LEED RATING



WAVE & PROX OPTIONS



PICTURE	PRODUCT NAME	MODEL FEATURES	POWER SUPPLY	CODE NUMBER	DRAWING
	PROX & WAVE SENSOR KIT FOR TOILET	<p>Suitable for duct concealed installations (plaster walls).</p> <p>Primary cleaning flush Allows the user to operate a cleaning flush before using the system. The 3 liters flush takes places when the user presents his hand at a short distance at the front of the sensor.</p> <p>Dual Flush The system will operate a half flush (3 liters) or a full flush (6 liters) based on a time and distance equation.</p>	<p>9V Battery / 9V Transformer (not included)</p>	<p>620100 (Prox & Wave program)</p>	

ELECTROMAGNETIC CISTERN SYSTEM

Concealed electronic flushing system for cistern activated by an infrared wave sensor.

Options for a single or dual flush activations. Includes an integral overflow pipe (warning pipe) to prevent flooding, and two integrated filters.

Pre-flush optional upon request. Hygiene flush is included. Flushing duration and other settings are adjustable by remote control.

Advantages:

- Drastically reduces water consumption
- No physical contact. Helps to protect users against cross contamination
- Cistern body in high density polyethylene , sensor unit/s in chrome plated brass
- Integral overflow flood prevention pipe
- Top and side access
- Sensor settings adjustable by remote control
- Easy installation.

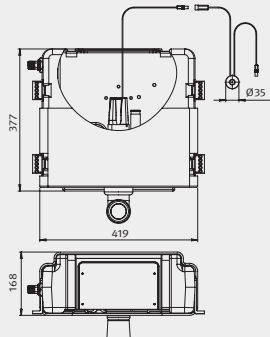
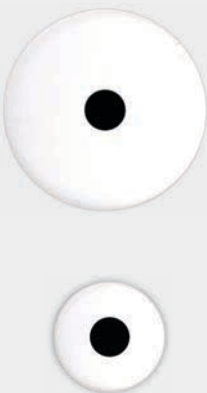
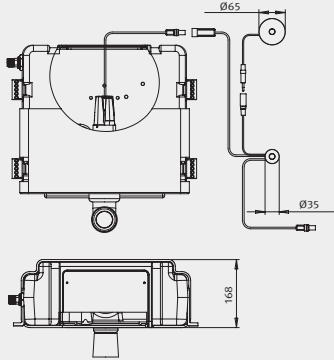

Hygiene Flush: To maximize hygiene, this product is equipped with a 24 hours duty flush. The flush takes place after 24 hours of non use have passed. Prevents the trap seal from drying out, possible freezing of pipes, and gets rid of potential bacteria in stuck water. This function can be disabled using the remote control.

PICTURE	PRODUCT NAME	MODEL FEATURES	POWER SUPPLY	CODE NUMBER	DRAWING
	ELECTROMAGNETIC SF CISTERN	<p>Single flush</p> <p>Allows flushing of the toilet once the users place their hands within a close distance to the sensor eye. In dual flush models, operating the small sensor will operate a half 3 liters flush, and operating the big sensor will operate a full 6 liters flush.</p>	12V 2.5 Amp IP68 Transformer	620620	
	ELECTROMAGNETIC DF CISTERN	<p>Dual flush</p> <p>Allows flushing of the toilet once the users place their hands within a close distance to the sensor eye. In dual flush models, operating the small sensor will operate a half 3 liters flush, and operating the big sensor will operate a full 6 liters flush.</p>	12V 2.5 Amp IP68 Transformer	620630	

**DUAL SERVICE ACCESS
(FRONT / TOP)**

**HALF FLUSH
3 LITERS SENSOR**

**CISTERN TANK
WITH INSTALLATION ACCESSORIES**

**FULL FLUSH
6 LITERS SENSOR**

***TOILET NOT INCLUDED**



IRON FRAME SETS

127-134



SOAP & WATER **129-130**
FRAME SETS



URINALS **131**
FRAME SETS



W.C. **132-133**
FRAME SETS



ARTIS G CISTERN **134**
FRAME SET

SOAP & WATER FRAME SETS

Iron mounting frame set.

For touch free soap dispenser and touch free faucet.

Operated by IR sensor, the system includes mounting support for the washbasin, faucet and dispenser.

Delivered ready for installation with all required accessories included.

* Washbasin not included



Advantages:

- Drastically reduces water consumption
- No physical contact. Helps to protect users against cross contamination.
- Provides a complete electronic soap and water experience as well as the complete installation package.
- Suitable for installations in solid or drywall construction
- Contains 9 mm holes for use in wood frame construction.
- Galvanized leg support, adjustable height 0-200 mm
- Powder coated, blue color
- Retractable leg supports to -50 mm.
- Rotating foot plate.
- Supplied with all the needed fixing accessories.
- Protection cover that protects the service opening against moisture and dirt and can be cut to length.
- Frame with C profile 40/40 mm.
- Frame height from 1140 mm to 1340 mm.
- Modular. Possibility to get only with the soap dispenser or only with the faucet.

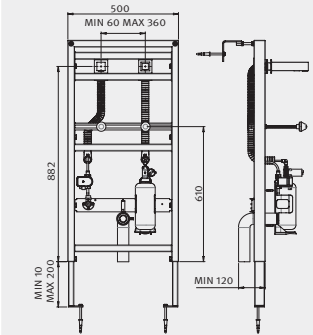

LEED RATING

PICTURE	PRODUCT NAME	POWER SUPPLY	CODE NUMBER	DRAWING
	D28 DP SOAP&WATER KE	12V Transformer and power splitter	500100	
	TUBULAR DP SOAP&WATER KE	12V Transformer and power splitter	500200	

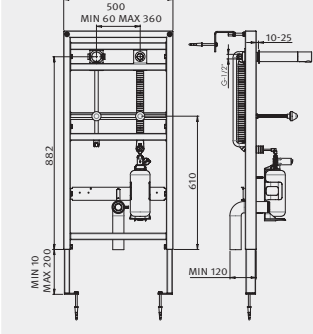
PICTURE	PRODUCT NAME	POWER SUPPLY	CODE NUMBER	DRAWING
<p>NEW</p> 	QUADRAT DP SOAP&WATER KE	12V Transformer and power splitter	500400	
<p>NEW</p> 	MALMO 1000 DP SOAP&WATER KE	12V Transformer and power splitter	500350	

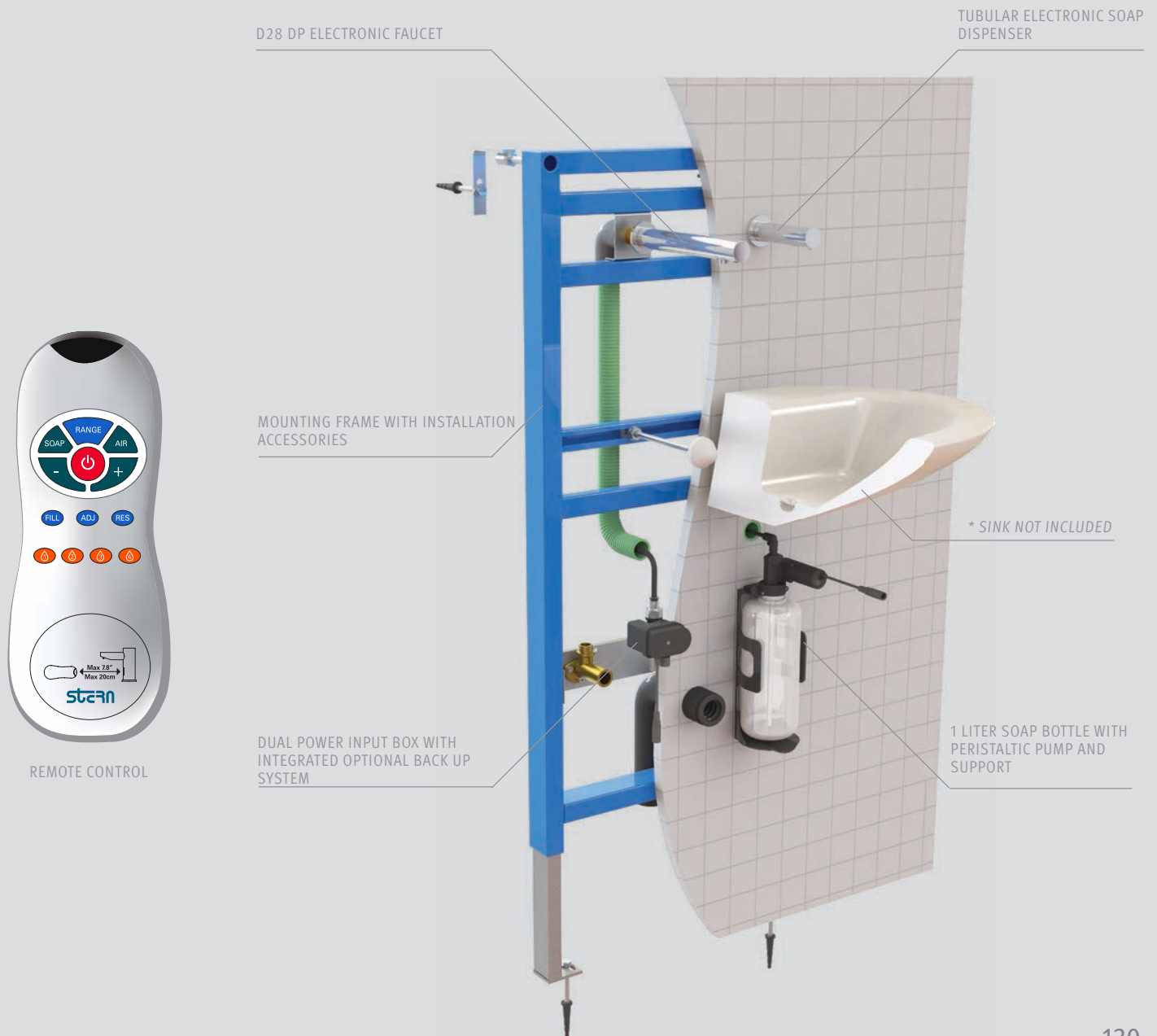

URINALS FRAME SETS

Iron mounting frame set.

Delivered ready for installation with flush valve and complete required accessories included.

* Urinal bowl not included

Advantages:



- Suitable for installations in solid or drywall construction
- Contains 9 mm holes for use in wood frame construction.
- Galvanized leg support, adjustable height 0-200 mm
- Powder coated, blue color
- Rotating foot plate.
- For structures on the floor, leg supports retractable to -50 mm.
- Stop valve with throttle pre-mounted.
- Protection cover that protects the service opening against moisture and dirt and can be cut to length.
- Frame with C profile 40/40 mm.
- Frame height from 1140 mm to 1340 mm.



Hygiene Flush: To maximize hygiene, this product is equipped with a 24 hours duty flush. The flush takes place after 24 hours of non use have passed. Prevents the trap seal from drying out, possible freezing of pipes, and gets rid of potential bacteria in stuck water. This function can be disabled using the remote control.

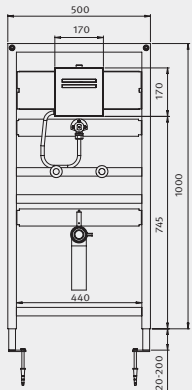

LEED RATING

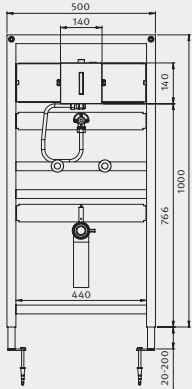
PICTURE	PRODUCT NAME	POWER SUPPLY	CODE NUMBER	DRAWING
	NARA 2030 K	9V Battery	800277	
	NARA 2030 KE	9V Transformer	800278	
	JUPITER 2040 K	9V Battery	800241	
	JUPITER 2040 KE	9V Transformer	800251	

W.C. FRAME SETS

Electronic WC Frame Set.

Galvanized steel iron frame system for wall hang toilets.

For concrete or dry walls with four (4) steel screws. Delivered ready for installation with flush valve and complete required accessories included.

* Toilet bowl not included

Advantages:

- Suitable for installations in solid or drywall construction
- Contains 9 mm holes for use in wood frame construction.
- Galvanized leg support, adjustable height 0-200 mm
- Powder coated, blue color
- Rotating foot plate.
- For structures on the floor, leg supports retractable to -50 mm.
- Supplied with all the needed fixing accessories.
- Stop valve with throttle pre-mounted.
- Protection cover that protects the service opening against moisture and dirt and can be cut to length.
- Frame with C profile 40/40 mm.
- Frame height from 1140 mm to 1340 mm.

Hygiene Flush: To maximize hygiene, this product is equipped with a 24 hours duty flush. The flush takes place after 24 hours of non use have passed. Prevents the trap seal from drying out, possible freezing of pipes, and gets rid of potential bacteria in stuck water. This function can be disabled using the remote control.



PICTURE	PRODUCT NAME	MODEL FEATURES	POWER SUPPLY	CODE NUMBER	DRAWING
	NARA 2032 K	Dual flush The sensor controls the flushing according to the time the user spends within the sensor range. If the user spends less than one (1) minute within the sensor range a reduced 3 liters flush will take place.	9V Battery	800271	
	NARA 2032 KE	If the user spends one (1) minute or more within the sensor range a full 6 liters flush will take place. Features a manual override flush activator button.	9V Transformer	800276	
	NARA 2032 PK	Dual flush The sensor controls the flushing according to the time the user spends within the sensor range. If the user spends less than one (1) minute within the sensor range a reduced 3 liters flush will take place.	9V Battery	800287	
	NARA 2032 PKE	If the user spends one (1) minute or more within the sensor range a full 6 liters flush will take place. Features touch override flush piezo button.	9V Transformer	800279	

W.C. FRAME SETS

Iron mounting frame set.

Galvanized steel iron frame system for wall hang toilets. Delivered ready for installation with flush valve and complete required accessories included. Options for touch or touch free operation.

* Toilet bowl not included

Advantages:

- Suitable for installations in solid or drywall construction
- Contains 9 mm holes for use in wood frame construction.
- Galvanized leg support, adjustable height 0-200 mm
- Powder coated, blue color
- Rotating foot plate.
- For structures on the floor, leg supports retractable to -50 mm.
- Supplied with all the needed fixing accessories.
- Stop valve with throttle pre-mounted.
- Protection cover that protects the service opening against moisture and dirt and can be cut to length.
- Frame with C profile 40/40 mm.
- Frame height from 1140 mm to 1340 mm.



Hygiene Flush: To maximize hygiene, this product is equipped with a 24 hours duty flush. The flush takes place after 24 hours of non use have passed. Prevents the trap seal from drying out, possible freezing of pipes, and gets rid of potential bacteria in stuck water. This function can be disabled using the remote control.



LEED RATING

PICTURE	PRODUCT NAME	MODEL FEATURES	POWER SUPPLY	CODE NUMBER	DRAWING
	VENUS COMFORT 2032 K	Dual flush IR system upon request. Features a manual override flush activator button.	9V Battery	800206	
	VENUS COMFORT 2032 KE		9V Transformer	800218	
	VENUS COMFORT 2032 DF K	Dual flush IR system upon request. Features two Piezo flush activator switches for each flush volume.	9V Battery	800221	
	VENUS COMFORT 2032 DF KE		9V Transformer	800236	
	PERFECT TIME 2032KE	Operated by a piezo switch integrated in the panel.	9V Transformer	800286	

ARTIS G

Electronic cistern frame set.

Touch free concealed cistern system, complete with an iron frame for wall hung toilet. Activated by a dual flush IR sensor. Includes a piezo flush button for alternative options, and an integral overflow pipe (warning pipe) to prevent flooding.

Includes a primary cleaning flush.

* Toilet bowl not included

Advantages:

- Drastically reduces water consumption
- No physical contact. Helps to protect users against cross contamination.
- Suitable for installations in solid or drywall construction
- Contains 9 mm holes for use in wood frame construction.
- Galvanized leg support, adjustable height 0-200 mm
- Powder coated, Blue color
- Rotating foot plate.
- For structures on the floor, leg supports retractable to -50 mm.
- Supplied with all the needed fixing accessories.
- Stop valve with throttle pre-mounted.
- Protection cover that protects the service opening against moisture and dirt and can be cut to length.
- Frame with C profile 40/40 mm.
- Frame height from 1140 mm to 1340 mm.

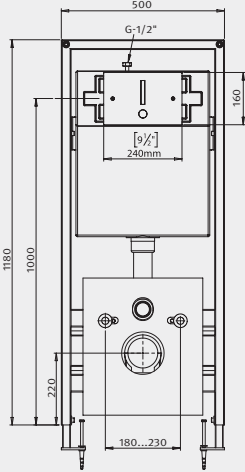

LEED RATING

PICTURE	PRODUCT NAME	MODEL FEATURES	POWER SUPPLY	CODE NUMBER	DRAWING
	ARTIS G	Features touch override flush piezo button.	IP68 encapsulated switching 12V adaptor	800410	

COMPONENTS &
ACCESSORIES

135-145



REMOTE CONTROLS [137-138](#)



SOAP DISPENSERS [138](#)
REMOTE CONTROLS



MIXING VALVES [139](#)



SOLENOID KEY [140](#)



PERFECT TIME [140](#)
CONTROL
ASSEMBLY



COVER PLATE [140](#)



DEFAULT [141](#)
TRANSFORMERS FOR
FAUCETS, URINALS,
TOILETS AND SHOWERS



IP68 [141](#)
ENCAPSULATED
TRANSFORMERS FOR
FAUCETS, URINALS,
TOILETS AND SHOWERS
FOR WET AREAS



IP68 ENCAPSULATED
SWITCHING
TRANSFORMERS FOR
CISTERNS [142](#)



TRANSFORMERS [142](#)
FOR SOAP
DISPENSERS



POWER SPLITTERS [143](#)



CABLE [143](#)
EXTENSIONS



JUNCTION BOXES [144](#)

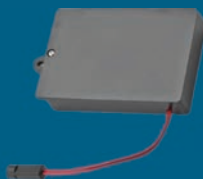

BATTERY BOXES [145](#)



DUAL POWER INPUT
BOXES [145](#)

REMOTE CONTROL

Allows easy maintenance of extensive installations requiring custom settings.

The remote control allows adjustment of sensor features for all Stern electronic products, while some functions require a compatible product model:

- Sensor range
- Entrance to the self adjustment mode
- Security time
- Short flow time
- Flow time
- Delay in
- Delay out
- 24 hour hygiene flush
- Lock out time
- Temporary off
- Reset

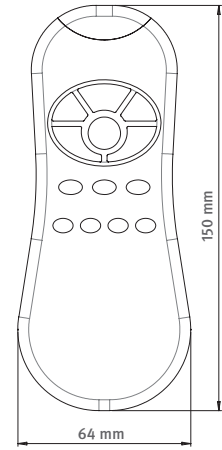

SOAP & WATER REMOTE CONTROL

Code Number: 07100014

NEW

In addition to the possibility to change settings at liquid or foam soap dispensers, this remote control allows to change settings at Stern matching touch free faucets. The following functions and settings can be changed:

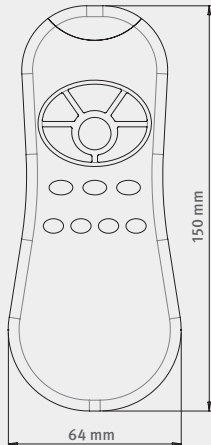

Availability: January 2018

LIQUID SOAP DISPENSERS REMOTE CONTROL

Adjustable settings:

- Soap dosage
- Soap tank refill
- Temporary shutoff function
- Reset to factory settings

PICTURE	CODE NUMBER	DRAWING
	07100008	

FOAM SOAP DISPENSERS REMOTE CONTROL

Adjustable settings:

- Soap dosage
- Soap tank refill
- Air quantity
- Reset to factory settings
- Temporary shutoff function

PICTURE	CODE NUMBER	DRAWING
	07100009	

INTEGRATED THERMOSTATIC MIXING VALVE

Advantages:

- Includes built in filters and check valves.
- Easy installation
- Thermostatic control for optimum temperature
- Can accommodate connection of up to three (3) faucets.



PREVENT SCALDING



PICTURE	PRODUCT NAME	MODEL FEATURES	CODE NUMBER	DRAWING
	INTEGRATED THERMOSTATIC MIXING VALVE	G - 1/2" inlet	07010198	
	INTEGRATED THERMOSTATIC MIXING VALVE 6-PACK		07201001	

MECHANICAL MIXING VALVE

Advantages:

- Includes built in filters and check valves.
- Easy installation
- An easy-to-use adjustment allowing pre-mix of hot and cold water.
- Enables the technical staff to manually set the water temperature at any given time.



PICTURE	PRODUCT NAME	MODEL FEATURES	CODE NUMBER	DRAWING
	STERN MIXING VALVE 3/8"	G - 3/8" inlet	200060	
	STERN MIXING VALVE 3/8" WITH NUT	G - 3/8" inlet	200065	
	STERN MIXING VALVE 1/2"	G - 1/2" inlet	200070	

SOLENOID KEY

Specially designed customized key for easy maintenance of the Stern solenoid valves.



PRODUCT NAME	CODE NUMBER	DRAWING
SOLENOID KEY	07590009	

PERFECT TIME SH CONTROL ASSEMBLY

Electronically operated self closing shower panel operated by touch. Operated by a Piezo button in the shower panel. Includes the control panel only.

Advantages:

- Drastically reduces water consumption
- No moving parts, ideal for heavy duty areas
- Non hold open feature
- Aluminum panel with Epoxy coating for high corrosion resistance
- Provides a retrofit solution for old shower systems. Conceals damage and prevents the need of replacing tiles.
- Stern and other manufacturers connectors available



PRODUCT NAME	CODE NUMBER	DRAWING
PERFECT TIME SH CONTROL ASSEMBLY	07040221	

COVER PLATE

28 mm / 4" deck panel kit. Offers a solution for deck mounted faucets to cover unused mounting holes.

Advantages:

- One hole cover panel, for single hole mount faucets
- Covers 28 mm diameter / 4" mounting holes
- Complete kit with gasket and screw















PRODUCT NAME	CODE NUMBER	DRAWING
COVER PLATE KIT	07275004	

PLUG IN TRANSFORMERS FOR FAUCETS, URINALS, TOILETS AND SHOWERS

Transformers with 5 meter cable male/female waterproof connector (CE, RoHS, UL).











TECHNICAL CHARACTERISTICS	
INPUT VOLTAGE	100 - 240V
OUTPUT VOLTAGE	9V
FREQUENCY	50 - 60 HZ
OUTPUT CURRENT	500 MA

PICTURE	PRODUCT NAME	CONNECTOR	CODE NUMBER	12-PACK CODE
	SWITCHING TRANSFORMER EU	MALE 	06522091	06540002
		FEMALE 	06522094	06540003
	SWITCHING TRANSFORMER UK	MALE 	06522088	06540004
		FEMALE 	06522093	06540005
	SWITCHING TRANSFORMER US	MALE 	06522090	06540006
		FEMALE 	06522092	06540007
	SWITCHING TRANSFORMER AU	MALE 	06522089	06540008
		FEMALE 	06522095	06540009

IP68 SWITCHING TRANSFORMERS FOR FAUCETS, URINALS, TOILETS AND SHOWERS

IP68 Switching transformer for wet areas with 5m cable and male/female waterproof connector (CE, RoHS, CB).







PRODUCT NAME	CONNECTOR	INPUT VOLTAGE	OUTPUT VOLTAGE	FREQUENCY	OUTPUT CURRENT	CODE NUMBER	7-PACK CODE
IP68 SWITCHING NO PLUG	MALE 	110-240V	9V	50/60 HZ	300 MA	06522065	06523000
	FEMALE 					06522070	06523001
IP68 SWITCHING EU	MALE 	110-240V	9V	50/60 HZ	300 MA	06522097	06523002
	FEMALE 					06522098	06523003
IP68 SWITCHING UK	MALE 	110-240V	9V	50/60 HZ	300 MA	06522101	06523004
	FEMALE 					06522102	06523005
IP68 SWITCHING US	MALE 	110-240V	9V	50/60 HZ	300 MA	06522099	06523006
	FEMALE 					06522100	06523007
IP68 SWITCHING AU	MALE 	110-240V	9V	50/60 HZ	300 MA	06522103	06523008
	FEMALE 					06522104	06523009

IP68 ENCAPSULATED SWITCHING TRANSFORMER FOR CISTERNS

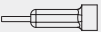
IP68 Encapsulated switching transformer with 5 meter cable and male/female waterproof connector (CE, RoHS,UL). Suitable for multiple products installation with electrical connection when combined with the appropriate power splitter. See page 143.

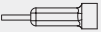

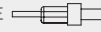



PRODUCT NAME	CONNECTOR	INPUT VOLTAGE	OUTPUT VOLTAGE	FREQUENCY	OUTPUT CURRENT	CODE NUMBER
IP68 ENCAPSULATED SWITCHING TRANSFORMER EU PLUG FOR CISTERNS	MALE 	110-240V	12V	50/60 HZ	2.5 A	06522077
	FEMALE 					06522078
IP68 ENCAPSULATED SWITCHING TRANSFORMER UK PLUG FOR CISTERNS	MALE 	110-240V	12V	50/60 HZ	2.5 A	06522071
	FEMALE 					06522072
IP68 ENCAPSULATED SWITCHING TRANSFORMER US PLUG FOR CISTERNS	MALE 	110-240V	12V	50/60 HZ	2.5 A	N/A
	FEMALE 					N/A

TRANSFORMERS FOR SOAP DISPENSERS

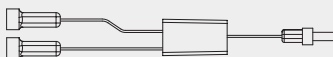

12V switching adaptor with 5 meter cable and male waterproof connector.

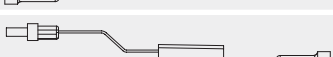
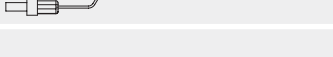
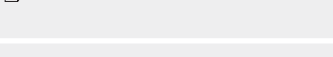
PICTURE	PRODUCT NAME	INPUT VOLTAGE	OUTPUT VOLTAGE	FREQUENCY	OUTPUT CURRENT	CODE NUMBER
	12V TRANSFORMER - UNIVERSAL INCLUDES PLUGS FOR EU, US AND UK	110-240V	12V	50/60 HZ	500 MA	06522082
	12V TRANSFORMER - EU	110-240V	12V	50/60 HZ	500 MA	06522081
	12V TRANSFORMER - USA	110-240V	12V	50/60 HZ	500 MA	06522080
	12V TRANSFORMER - AU	110-240V	12V	50/60 HZ	500 MA	06522085
	12V TRANSFORMER - UK	110-240V	12V	50/60 HZ	500 MA	06522086

POWER SPLITTERS

DRAWING	PRODUCT NAME	MODEL FEATURES	CODE NUMBER
	POWER SPLITTER 2 WAYS F-M2	Cable length to product: 100 mm Cable length to power supply: 100 mm	06001001
	POWER SPLITTER 2 WAYS M-F2	Cable length to product: 100 mm Cable length to power supply: 100 mm	06001004
	POWER SPLITTER 3 WAYS F-M3	Cable length to product: 100 mm Cable length to power supply: 100 mm	06001002
	POWER SPLITTER 2 WAYS M-F3	Cable length to product: 100 mm Cable length to power supply: 100 mm	06001005
	POWER SPLITTER SOAP & WATER 2 WAYS F-M/F	To be used with 12V transformer. For connection of one soap dispenser and one faucet. Cable length to product: 100 mm. Cable length to power supply: 100 mm	06001025
	POWER SPLITTER SOAP 2 WAYS F-M2	To be used with 12V, 2.5 A transformer. For multiple connection of 2 soap dispensers. Cable length to product: 500 mm Cable length to power supply: 100 mm	06001026
	POWER SPLITTER SOAP 3 WAYS F-M3	To be used with 12V, 2.5 A transformer. For multiple connection of 3 soap dispensers. Cable length to product: 1X500 mm, 2X1500 mm. Cable length to power supply: 100 mm	06001027
	POWER SPLITTER SOAP 4 WAYS F-M4	To be used with 12V, 2.5 A transformer. For multiple connection of 4 soap dispensers. Cable length to product: 2X500 mm, 2X1500 mm. Cable length to power supply: 100 mm	06001028

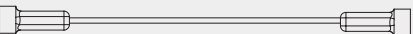
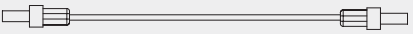
CABLE EXTENSION

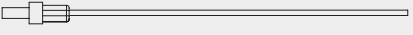
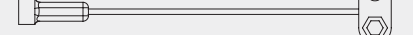
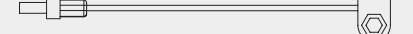
DRAWING	PRODUCT NAME	CODE NUMBER
	CABLE EXTENSION 100 MM MALE/FEMALE	06000064
	CABLE EXTENSION 100 MM MALE/MALE	06009018
	CABLE EXTENSION 100 MM FEMALE/FEMALE	06009022
	CABLE EXTENSION 100 MM MALE/FEMALE	06000004
	CABLE EXTENSION 100 MM FEMALE/OPEN	06000003
	CABLE EXTENSION 100 MM MALE/BATTERY	06000029
	CABLE EXTENSION 100 MM FEMALE/BATTERY	06000050

JUNCTION BOXES

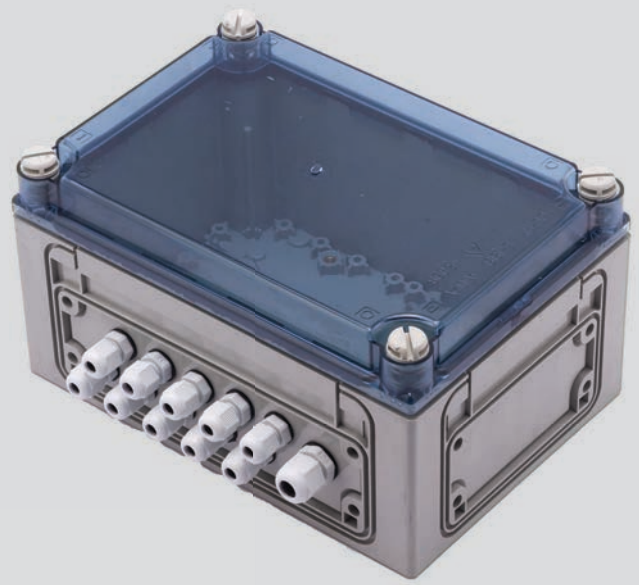



DRAWING	PRODUCT NAME	MODEL FEATURES	INPUT VOLTAGE	OUTPUT VOLTAGE	FREQUENCY	OUTPUT CURRENT	CODE NUMBER
	JUNCTION BOX WITH TRANSFORMER FOR FAUCETS, URINALS, TOILETS AND SHOWERS	Connection point of up to 10 products together. Includes a 12VDC 2 Amp power supply transformer	115-230V	12V	60 HZ	2.1 A	06530013
	JUNCTION BOX WITH TRANSFORMER FOR SOAP DISPENSERS	Connection point of up to 10 Soap Dispensers or 10 ring illuminated products. Includes a 12VDC 4.2 Amp power supply transformer.	115-230V	12V	60 HZ	4.2 A	06530062

CABLES FOR JUNCTION BOX

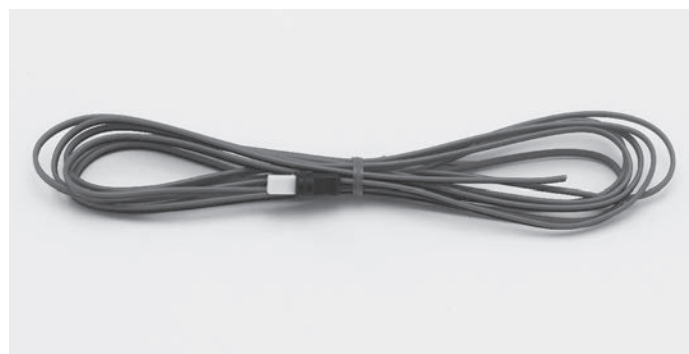
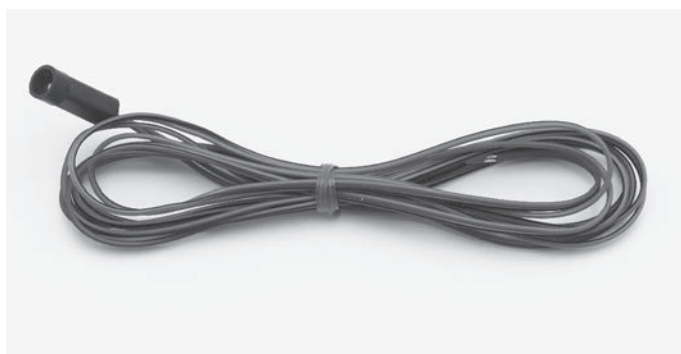
DRAWING	PRODUCT NAME	MODEL FEATURES	CODE NUMBER
	OUTPUT CABLE FOR JUNCTION BOX	3 meters male connector	06000084
	OUTPUT CABLE FOR JUNCTION BOX	3 meters female connector	06000086



BATTERY BOXES



PICTURE	PRODUCT NAME	REQUIRED BATTERIES	CONNECTOR	CODE NUMBER	12- PACK CODE	15-PACK CODE
	IP67 BLACK BATTERY BOX	6x1.5V AA batteries	Male waterproof connector	06530092	N/A	06533002
		6x1.5V AA batteries (Not supplied)		06530096	N/A	06533000
		6x1.5V AA batteries	Female waterproof connector	06530093	N/A	06533003
		6x1.5V AA batteries (Not supplied)		06530091	N/A	06533001
	IP67 9V BLACK BATTERY BOX	9V Battery (Alkaline or Lithium)	Male waterproof connector	06530080	N/A	N/A
			Female waterproof connector	06530089	N/A	N/A
	BATTERY BOX FOR SOAP DISPENSERS	6xDD batteries	Male waterproof connector	06530041	N/A	N/A

DUAL POWER INPUT BOXES

The dual power input box can be used to power products with a 9V battery or a 9V transformer.

When used with a transformer it has an integrated automatic battery back-up to be used with a 9V Lithium battery, which enables the product to be used normally in case of a power failure.

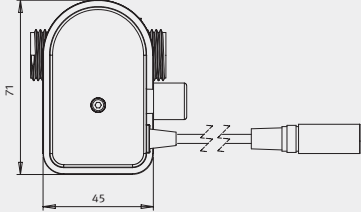

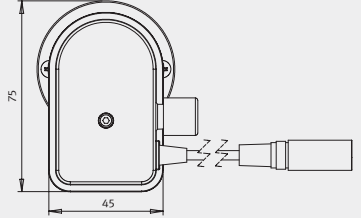
PICTURE	PRODUCT NAME	MODEL FEATURES	CODE NUMBER	DRAWING
	DUAL POWER INPUT BOX	For applications in which the solenoid valve is located externally. 4 contacts connector.	06522042	
	DUAL POWER INPUT BOX 1000	For applications in which the solenoid valve is located inside the product body. 4 contacts connector.	06522061	

BACK UP DEVICE WITH IP67 BOX

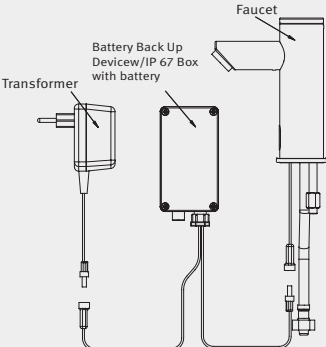
PRODUCT NAME	MODEL FEATURES	CONNECTOR	CODE NUMBER	DRAWING
BACK UP DEVICE WITH IP67 BOX	Battery back up system for powering Stern's 9V transformer operated products when a power supply failure occurs. Lithium battery not included.	Male connector	06530033	
		Female connector	06530032	



ALPHABETIC INDEX

PRODUCT	PART NUMBER	PAGE
12V transformer - AU	06522085	142
12V transformer - EU	06522081	142
12V transformer - Universal	06522082	142
12V transformer - USA	06522080	142
12V transformer - UK	06522086	142
Apollo ALB	340600	52
Apollo ALE	340700	52
Apollo Free	340100	55
Apollo Medical B	314500	53
Apollo Medical E	314510	53
Apollo Medical FB	314530	53
Apollo Medical FE	314540	53
APS Kit for faucet	07225008	56
APS kit for Toilet	07225018	123
APS Threaded rod Kit shower	07226054	106
Artis G	800410	134
Back up device with IP67 box female connector	06530032	145
Back up device with IP67 box male connector	06530033	145
Battery box for soap dispensers	06530041	145
BTM soap dispenser B	280210	90
BTM soap dispenser E	280200	53
BTM Foam E	280250	53
BTM Faucet E	280300	89
BTM Faucet B	280310	89
Cable extension 100 mm female/battery	06000050	143
Cable extension 100 mm female/female	06009022	143
Cable extension 100 mm female/open	06000003	143
Cable extension 100 mm male/battery	06000029	143
Cable extension 100 mm male/female	06000064	143
Cable extension 100 mm male/open	06000004	143
Cable extension 100 mm male/male	06009018	143
Classic AB 1953	291010	30
Classic 1000 AB 1953	292020	30
Classic 1000 B AB 1953	292120	30
Classic 1000 E AB 1953	292230	30
Classic B AB 1953	291110	30
Classic E AB 1953	291210	30
Classic CS B	293100	30
Classic CS E	293200	30
Classic Foam E	292300	59
Classic Soap Dispenser B	292400	59
Classic Soap Dispenser E	292410	59
Classic Foam 6-pack E	292300	60
Classic SD B 6-pack	250921	60
Classic SD E 6-pack	250911	60
Classic SD 1.6 E	292416	60
Condor	210000	31
Condor 1010	210100	31
Condor 1010 E	210300	31
Condor E	210200	31
Cool B	280115	34
Cool BRE	280100	34

PRODUCT	PART NUMBER	PAGE
Cool E	280110	34
Cool GB	280125	34
Cool GBRE	280120	34
Cool GE	280130	34
Cover Plate	07275004	140
Cubica 2030 B	360300	51
Cubica 2030 E	360400	51
Cubica B	360100	51
Cubica E	360200	51
D28 B	352000	38
D28 B AISI316	352130	38
D28 DP Soap&Water KE	500100	129
D28 DPB	352300	38
D28 DPB AISI316	352301	38
D28 DPE	352400	38
D28 DPE AISI316	352401	38
D28 E	352100	38
D28 E AISI316	352120	38
D28 Prox B	352600	38
D28 Prox E	352610	38
D28 Touch Dual Power B	352700	39
D28 Touch Dual Power E	352710	39
Dolphin 1000 FB	270320	32
Dolphin 1000 FE	270330	32
Dolphin FB	270170	32
Dolphin FE	270180	32
Dolphin GB	270120	32
Dolphin GE	270220	32
Dual power input box	06522042	145
Dual power input box 1000	06522061	145
Easy 1000 B	246050	26
Easy 1000 E	246060	26
Easy B	246010	26
Easy E	246020	26
Electromagnetic SF cistern	620620	125
Electromagnetic DF cistern	620630	125
Elite 1000 B	236700	15
Elite 1000 B with technician's mixer	236720	16
Elite 1000 E	236800	15
Elite 1000 E with technician's mixer	236805	16
Elite 1000 LB	236550	16
Elite 1000 LE	236650	16
Elite 1000 Plus B	236750	16
Elite 1000 Plus E	236850	16
Elite SD 1.6 E	236216	66
Elite SD 1.6 E AISI316	236126	68
Elite B	236300	15
Elite E	236400	15
Elite foam	236120	65
Elite foam 6-pack E	236121	66
Elite foam 6-pack E AISI316	236123	68
Elite foam soap dispenser E	236120	65
Elite foam soap dispenser E AISI316	236120	67
Elite LB	236500	15
Elite LE	236600	15

ALPHABETIC INDEX

PRODUCT	PART NUMBER	PAGE
Elite Plus B	236350	16
Elite Plus E	236450	16
Elite SD 6-pack B	236111	66
Elite SD 6-pack B AISI316	236114	68
Elite SD 6-pack E	236101	66
Elite SD 6-pack E AISI316	236117	68
Elite soap dispenser B	236110	65
Elite soap dispenser B AISI316	236113	67
Elite soap dispenser E	236100	65
Elite soap dispenser E AISI316	236103	67
Elite soap dispenser plus B	236107	66
Elite soap dispenser plus B AISI316	236109	68
Elite soap dispenser plus E	236105	66
Elite soap dispenser plus E AISI316	236104	68
Extension kit Apollo AL	07240060	52
Extension kit for wave/prox sensor	07240061	52
Extreme 1000 BRE	237005	11
Extreme 1000 Plus B	237150	10
Extreme 1000 Plus E	237050	10
Extreme 1000B	237100	9
Extreme 1000E	237000	9
Extreme B	237200	9
Extreme BRE	237305	11
Extreme CS B	237801	48
Extreme CS E	237800	48
Extreme CS DPB	237802	48
Extreme CS DPE	237803	48
Extreme CS soap dispenser B	237891	79
Extreme CS soap dispenser B AISI316	237891-316	79
Extreme CS soap dispenser E	237890	79
Extreme CS soap dispenser E AISI316	237890-316	79
Extreme E	237300	9
Extreme Habitat E	237040	11
Extreme HLB	237317	10
Extreme HLE	237316	10
Extreme Plus B	237250	10
Extreme Plus E	237350	10
Extreme LFB	237820	12
Extreme LFE	237810	12
Extreme LFE AISI316	237811	12
Extreme SD 1.6 E	237916	64
Extreme soap dispenser B	237920	63
Extreme soap dispenser B 6-pack	237921	64
Extreme soap dispenser E	237900	63
Extreme SD 6-pack B	237921	64
Extreme SD 6-pack E	237901	64
Extreme soap dispenser plus B	237922	63
Extreme soap dispenser plus E	237905	63
Extreme Tempra E	237070	11
Extreme touch 1000 B	237110	13
Extreme touch 1000 BRE	237020	13
Extreme touch 1000 E	237010	13
Extreme touch B	237210	13
Extreme touch BRE	237320	13

PRODUCT	PART NUMBER	PAGE
Extreme touch E	237310	13
Foam soap dispensers remote control	07100009	138
Foot washfree	113730	105
Foot Washfree 3000	113720	105
Free	113100	112
Free E	113200	112
Free SP	800504	112
Green AB 1953	225901	20
Green 1000 AB 1953	225801	20
Green 1000 B AB 1953	225871	20
Green 1000 BRE AB 1953	225891	20
Green 1000 E AB 1953	225821	20
Green 28 foam E	352920	72
Green 28 SD 6-pack B	352901	72
Green 28 SD 6-pack E	352911	72
Green 28 soap dispenser B	352900	72
Green 28 soap dispenser E	352910	72
Green 28 SD 1.6 E	352916	72
Green B AB 1953	225951	20
Green BRE AB 1953	225921	20
Green E AB 1953	225941	20
Green foam E	225842	70
Green foam 6-pack E	225843	70
Green SD 6-pack B	225846	70
Green SD 6-pack E	225841	70
Green SD 1.6 E	225816	70
Green soap dispenser B	225845	70
Green soap dispenser E	225840	70
Green time AB 1953	225911	22
Green time 1000 AB 1953	225811	22
Green time 1000 B AB 1953	225881	22
Green time 1000 BRE AB 1953	225836	22
Green time 1000 E AB 1953	225831	22
Green time B AB 1953	225981	22
Green time BRE AB 1953	225926	22
Green time E AB 1953	225971	22
Integrated thermostatic mixing valve	07010198	139
Integrated thermostatic mixing valve 6-pack	07201001	139
IP67 9V Black battery box female connector	06530080	145
IP67 9V Black battery box male connector	06530089	145
IP67 Black battery box female connector (without batteries)	06530091	145
IP67 Black battery box female connector	06530093	145
IP67 Black battery box male connector (without batteries)	06530083	145
IP67 Black battery box male connector	06530092	145
IP68 Switching transformer no plug male connector	06522065	141
IP68 Switching transformer no plug female connector	06522070	141
IP68 Switching transformer EU male connector	06522097	141
IP68 Switching transformer EU female connector	06522098	141
IP68 Switching transformer UK male connector	06522101	141
IP68 Switching transformer UK female connector	06522102	141
IP68 Switching transformer US male connector	06522099	141
IP68 Switching transformer US female connector	06522100	141

ALPHABETIC INDEX

PRODUCT	PART NUMBER	PAGE	PRODUCT	PART NUMBER	PAGE
IP68 Switching transformer AU male connector	06522103	141	MF Tubular Soap Dispenser	07292076	76
IP68 Switching transformer AU female connector	06522104	141	MF Tubular Foam Dispenser AISI316	07292231	78
IP68 Encapsulated switching transformer eu plug for cisterns female connector	06522078	142	MF Tubular Soap Dispenser AISI316	07292221	78
IP68 Encapsulated switching transformer EU plug for cisterns male connector	06522077	142	Multifeed kit	07220096	90
IP68 Encapsulated switching transformer UK plug for cisterns female connector	06522072	142	Nara 2022	160750	118
IP68 encapsulated switching transformer UK plug for cisterns male connector	06522071	142	Nara 2022 E	160700	118
Junction box with transformer for faucets, urinals, toilets and showers	06530013	144	Nara 2030	170200	110
Junction box with transformer for soap dispensers	06530062	144	Nara 2030 E	170100	110
Jupiter 1011	132100	111	Nara 2030 K	800277	131
Jupiter 1032	134510	111	Nara 2030 KE	800278	131
Jupiter 1032 E	134520	111	Nara 2032	160310	116
Jupiter 2040	125900	109	Nara 2032 E	160410	116
Jupiter 2040 E	125901	109	Nara 2032 K	800271	132
Jupiter 2040 H	125910	109	Nara 2032 KE	800276	132
Jupiter 2040 HE	125911	109	Nara 2032 P	160610	116
Jupiter 2040 K	800241	131	Nara 2032 PE	160510	116
Jupiter 2040 KE	800251	131	Nara 2032 PK	800287	132
Jupiter 3002 EM	140315	113	Nara 2032 PKE	800279	132
Jupiter 3002 M	140215	113	Nara ECO 2032	160320	116
Jupiter M 0.5 GPF	140112	113	Nara ECO 2032 E	160330	116
Jupiter ME 0.5 GPF	140516	113	Nara ECO 2032 PE	160340	116
Long bracket 200 mm (Washfree 1000)	07055175	55	Nara Q	360510	51
Malmo	225865	40	Nara QE	360500	51
Malmo 1000	225860	40	Neptune 1011	610261	104
Malmo 1000 DP Soap&Water KE	500350	130	Neptune 1032	613200	103
Medical 1000 TE	314600	53	Neptune 1032 E	613400	103
MF Behind mirror SD	07292223	90	Neptune 1042 T	612280	99
MF Classic Foam Dispenser	07292207	60	Neptune 1042 TE	612281	99
MF Classic soap Dispenser	07292177	60	Neptune Medical 1000 T	610250	101
MF Elite Foam Dispenser	07292205	66	Neptune Medical 1000 T Bottom outlet	610255	101
MF Elite SD Plus	07292093	66	Neptune shower panel 1000 TB	602410	96
MF Elite Soap Dispenser	07292077	66	Neptune shower panel 1000 TE	604410	96
MF Elite Foam Dispenser AISI316	07292240	68	Neptune shower panel B	601410	96
MF Elite SD Plus AISI316	07292241	68	Neptune shower panel E	603410	96
MF Elite Soap Dispenser AISI316	07292239	68	Output cable for junction box	06000084	144
MF Extreme Plus Soap Dispenser	07292095	64	Output cable for junction box	06000086	144
MF Extreme Soap Dispenser	07292056	64	Perfect time SH 1032	613700	103
MF Green 28 Foam Dispenser	07292206	72	Perfect time SH 1032 E	613800	103
MF Green 28 Soap Dispenser	07292155	72	Perfect time 1042 T	612253	100
MF Green Foam Dispenser	07292228	70	Perfect time 1042 TE	612254	100
MF Green Soap Dispenser	07292062	70	Perfect time 2032 E	410761	120
MF Quadrat 2030 Soap Dispenser	07292094	74	Perfect time 2032KE	800286	133
MF Quadrat Soap Dispenser	07292078	74	Perfect time SH control assembly	07040221	140
MF Trendy Foam Dispenser	07292183	62	Perfect time SH 1011	610600	104
MF Trendy Plus Soap Dispenser	07292099	62	Perfect Time shower panel 1000 TB	602400	98
MF Trendy Soap Dispenser	07292073	62	Perfect Time shower panel 1000 TB w/ hand shower	602401	98
MF Tubular Soap Dispenser 2030	07292081	76	Perfect Time shower panel 1000 TE	604400	98
MF Tubular Foam Dispenser	07292186	76	Perfect Time shower panel 1000 TE w/ hand shower	604401	98
			Perfect Time shower panel B	601400	98
			Perfect Time shower panel E	603400	98
			Perfect Time shower panel LB	601402	96

ALPHABETIC INDEX

PRODUCT	PART NUMBER	PAGE	PRODUCT	PART NUMBER	PAGE
Piezo kit for W.C. with distant control	07226042	122	Smart B	235100	18
Power splitter 2 ways F-M2	06001001	143	Smart E	235200	18
Power splitter 2 ways M-F2	06001004	143	Smart LB	235110	18
Power splitter 2 ways M-F3	06001005	143	Smart LE	235210	18
Power splitter 3 ways F-M3	06001002	143	Smart Plus B	235150	18
Power splitter soap & water 2 ways F-M2	06001025	143	Smart Plus E	235250	18
Power splitter soap 2 ways F-M2	06001026	143	Solenoid Key	07590009	140
Power splitter soap 3 ways F-M3	06001027	143	Stern mixing valve 1/2"	200070	139
Power splitter soap 4 ways F-M4	06001028	143	Stern mixing valve 3/8"	200060	139
PPS high security kit for shower	07226033	106	Stern mixing valve 3/8" with nut	200065	139
Programmable piezo kit for shower	07225019	106	SWA Module	280400	88
Programmable piezo kit for beach shower columns	07226050	106	SWAR Module	280460	85
Prox & wave sensor kit for toilet	620100	124	SWA HI-SPEED Module	280410	86
Prox kit for toilet	620100	123	Swan 1000 AB 1953	252210	28
Prox Kit for faucet	620200	56	Swan 1000 B AB 1953	252310	28
Prox Kit for shower	620000	106	Swan 1000 BM	252301	28
Prox Kit for Urinal	620700	114	Swan 1000 E AB 1953	252420	28
Prox Kit for toilet	620100	123	Swan 1000 EM	252401	28
Prox kit front fixation for urinal	620750	114	Swan 1010 AB 1953	250220	28
Quadrat 2030 B	351300	50	Swan 1010 B AB 1953	250310	28
Quadrat 2030 E	351400	50	Swan 1010 E AB 1953	250420	28
Quadrat 2030 LB	351305	50	Switching transformer AU female connector	06522095	141
Quadrat 2030 LE	351405	50	Switching transformer AU male connector	06522089	141
Quadrat 2030 SD 1.6 E	351316	74	Switching transformer EU female connector	06522094	141
Quadrat 2030 soap dispenser 6-pack B	351921	74	Switching transformer EU male connector	06522091	141
Quadrat 2030 soap dispenser 6-pack E	351931	74	Switching transformer UK female connector	06522093	141
Quadrat B	351100	50	Switching transformer UK male connector	06522088	141
Quadrat E	351200	50	Switching transformer US female connector	06522092	141
Quadrat DP Soap&Water KE	500400	130	Switching transformer US male connector	06522090	141
Quadrat LB	351105	50	Thermix SH 1000 T	610400	102
Quadrat LE	351205	50	Top Filling Multifeed Kit	07220090	81
Quadrat SD 1.6 E	351916	74	Top Filling Multifeed Kit with Soap Level Indicator	07220152	81
Quadrat soap dispenser 2030 B	351920	73	Touch B	225100	24
Quadrat soap dispenser 2030 E	351930	73	Touch BRE	225500	24
Quadrat soap dispenser B	351910	73	Touch E	225200	24
Quadrat soap dispenser 6-pack B	351911	74	Touch Free B AB 1953	225610	23
Quadrat soap dispenser E	351900	73	Touch Free E AB 1953	225710	23
Quadrat soap dispenser 6-pack E	351901	74	Touch SH 1000 T	620710	102
Remote Control	07100005	137	Touch SH 1000 T Bottom outlet	620700	102
Remote control for foam soap dispensers	07100009	138	Trendy 1000 BRE	239305	5
Remote control for liquid soap dispenser	07100008	138	Trendy 1000 Plus B	239250	4
Remote control for soap & water	07100014	138	Trendy 1000 Plus E	239350	4
Set of pipes	07291037	116, 118	Trendy 1000B	239200	4
SH 3000	600100	93	Trendy 1000E	239300	4
SH 9000	600400	93	Trendy 1000LB	239600	4
SH 9020	600420	93	Trendy 1000 LE	239700	4
Sleeve Kit for SH 9000	07240046	93	Trendy B	239000	4
Smart 1000 B	235500	18	Trendy BRE	239105	5
Smart 1000 E	235600	18	Trendy E	239100	4
Smart 1000 LB	235510	18	Trendy Foam E	239930	61
Smart 1000 LE	235610	18			
Smart 1000 Plus B	235550	18			
Smart 1000 Plus E	235650	18			

ALPHABETIC INDEX

PRODUCT	PART NUMBER	PAGE	PRODUCT	PART NUMBER	PAGE
Trendy Habitat	239340	5	Tubular 2030 SD 1.6 E AISI316	350916	78
Trendy LB	239400	4	Tubular SD 2030 6-pack B AISI316	350991	78
Trendy LE	239500	4	Tubular SD 2030 6-pack E AISI316	350984	78
Trendy Plus B	239050	4	Tubular SD 6-pack B AISI316	350992	78
Trendy Plus E	239150	4	Tubular SD 6-pack E AISI316	350933	78
Trendy SD 1.6 E	239916	62	Tubular soap dispenser 2030 B	350922	75
Trendy SD B 6-Pack	239911	62	Tubular soap dispenser 2030 E	350927	75
Trendy SD E 6-Pack	239902	62	Tubular soap dispenser B	350920	75
Trendy soap dispenser B	239910	61	Tubular soap dispenser E	350925	75
Trendy soap dispenser E	239900	61	Tubular soap dispenser B AISI316	350919	77
Trendy soap dispenser plus B	239912	62	Tubular soap dispenser E AISI316	350924	77
Trendy soap dispenser plus E	239902	62	Tubular soap dispenser 2030 B AISI316	350918	77
Trendy TB	236930	7	Tubular soap dispenser 2030 E AISI316	350917	77
Trendy TE	236935	7	Tubular TB	350202	43
Trendy Tempra E	239410	5	Tubular TE	350102	43
Trendy touch 1000 B	239220	6	Tubular touch 2030 B	350350	45
Trendy touch 1000 BRE	239330	6	Tubular touch 2030 BRE	350460	46
Trendy touch 1000 E	239320	6	Tubular touch 2030 BR LE	350330	46
Trendy touch B	239020	6	Tubular touch 2030 E	350450	45
Trendy touch BRE	239130	6	Tubular touch 2030 LB	350320	45
Trendy touch E	239120	6	Tubular touch 2030 LE	350420	45
Tubular 1000 B	350800	43	Tubular touch B	350140	45
Tubular 1000 B Box	350900	43	Tubular touch BRE	350170	46
Tubular 1000 E	350850	43	Tubular touch BR LE	350180	46
Tubular 1000 E Box	350950	43	Tubular touch E	350130	45
Tubular 2030 B	350300	42	Tubular touch LB	350250	45
Tubular 2030 E	350400	42	Tubular touch LE	350150	45
Tubular 2030 LB	350310	42	Tubular wave DP LE	350190	44
Tubular 2030 LE	350410	42	Tubular XLB	350215	43
Tubular B	350200	41	Tubular XLE	350415	43
Tubular B AISI316	350208	41	Under the deck Multifeed kit	07220096	81
Tubular CB	350500	42	Venus 1.28 GPF	420242	121
Tubular CE	350600	42	Venus 3002	420255	121
Tubular DMB	350700	25	Venus 3002 E	420231	121
Tubular DME	350750	25	Venus 3002 R	420241	121
Tubular DP Soap&Water KE	500200	129	Venus 3002 RE	420265	121
Tubular E	350100	41	Venus 3003R PE	420280	121
Tubular E AISI316	350109	41	Venus comfort 2032	410562	119
Tubular foam E	350980	76	Venus comfort 2032 DF	410446	120
Tubular foam E AISI316	350982	78	Venus Comfort 2032 DF K	800221	133
Tubular foam 6-pack E	350980	76	Venus Comfort 2032 DF KE	800236	133
Tubular foam 6-pack E AISI316	350983	78	Venus comfort 2032 DFE	410447	120
Tubular LB	350210	42	Venus comfort 2032 E	410541	119
Tubular LE	350120	42	Venus Comfort 2032 K	800206	133
Tubular Perth B	350207	43	Venus Comfort 2032 KE	800218	133
Tubular Perth E	350107	43	Venus comfort 2032 P	410576	119
Tubular SD 2030 B 6-pack	350923	76	Venus comfort 2032 PE	410546	119
Tubular SD 2030 E 6-pack	350928	76	Venus E 1.28 GPF	420232	121
Tubular SD 1.6 E	350116	76	Venus XS 2032 E	410601	119
Tubular SD 1.6 E AISI316	350932	78	Washfree 1000	316010	55
Tubular SD 6-pack B	350921	76	Wave Kit for faucet	620400	56
Tubular SD 6-pack E	350926	76	Wave Kit for shower	620810	106
Tubular 2030 SD 1.6 E	350816	76	Wave on-off kit for toilet	620600	123



STERN ENGINEERING LTD.

HEADQUARTERS:	USA:
15 Gan Rave Blvd.	777 Passaic Avenue
8122214, Yavne, Israel	Clifton NJ, 07012
Tel: +972-8932-6000	Tel: +1-973 773 8011
info@sternfaucets.com	Toll Free: 1-800-4364410
	sales@sternfaucets.com

www.sternfaucets.com
www.sternfaucets.es